



STANDARD COMPONENTS SPARE PARTS LISTS

Click on the model number below that correspondes with your equipments model number.

Note the pictures shown are for visual representation only and do not accurately portray each component.

For pricing and availability contact our spare parts department at 317-545-7171 ext. 2104 or spares@moorfeed.com

BOWL DRIVE UNIT MODEL LIST

4.5" Drives	70401	70402	70403	70404				
6" Drives	70603	70604	70605	70606				
8" Drives	70801	70802	70803	70804				
10" Drives	71003	71004	71005	71006				
12" Drives	71203	71204	71205	71206				
15" Drives	71503	71504	71505	71506				
18" Drives	71803	71804	71805	71806				
21" Drives	72127	72128	72132	72134	72139	72141	72142	72143
	72166	72167	72168	72169	72187	72188	72190	72195
24" Drives	72413	72414	72415	72416	72427	72428	72429	72430
	72439	72440	72441	72442	72447	72448	72449	72450
27" Drives	72735	72736	72737	72738				
30" Drives	73035	73036	73037	73038	73043	73044	73045	73046
36" Drives	73635	73636	73637	73638	73643	73644	73697	73698

INLINE DRIVE MODEL LIST

S-2	78141	78181	M-2	78171	78191
S-3	78142	78182	M-3	78172	78192
S-4	78143	78183	M-4	78173	78193
S-5	78144	78184	M-5	78174	78194
S-6	78145	78185	M-6	78175	78195
8.5"	78801	78803	16"	780004	780005

MOORFEED DRIVE UNIT SPARE PARTS LIST

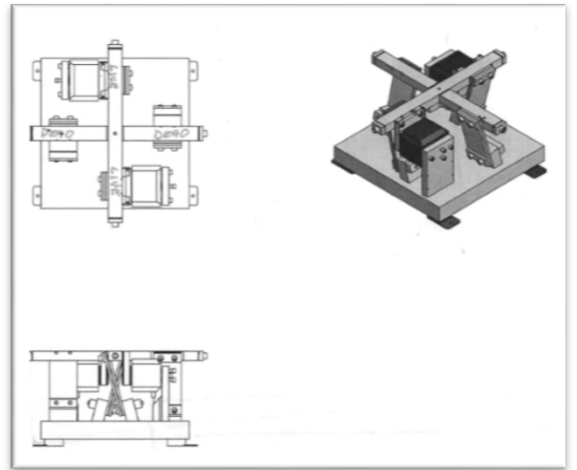

DRIVE UNIT MODEL #

70401

DRIVE UNIT SIZE: 4.5"

DRIVE UNIT VOLTAGE: 120 VOLTS AC

DRIVE FREQUENCY: FULL WAVE

NUMBER OF POSTS: 4

DRIVE ROTATION: CW

COIL PART NUMBER: 83805

SPRING INFORMATION:

SIZE: 1/8"
PART #: 70616

SPACER INFORMATION:

PART #: 81018

TOE CLAMP PART NUMBER: 70618

MOUNTING FOOT PART NUMBER: 78812

CROSS ARM PART NUMBER: 70417

**RECOMMENDED
QUANTITY**

1 EACH

8 EACH

16 EACH

2 EACH

2 EACH

ADDITIONAL DRIVE UNIT INFORMATION:

MAY REQUIRE ADDITIONAL SPRINGS FOR TUNING SUCH AS:

1/16" (P/N 70646) AND 3/32" (P/N 70647)

CONTACT MOORFEED FOR PRICING AND AVAILABILITY.

PHONE: (317) 545-7171 FAX: (317) 542-7317 EMAIL: SPARES@MOORFEED.COM

MOORFEED DRIVE UNIT SPARE PARTS LIST

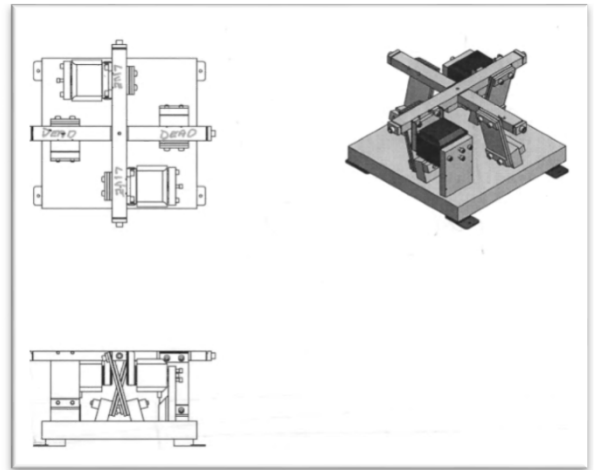

DRIVE UNIT MODEL #

70402

DRIVE UNIT SIZE: 4.5"

DRIVE UNIT VOLTAGE: 120 VAC

DRIVE FREQUENCY: FULL WAVE

NUMBER OF POSTS: 4

DRIVE ROTATION: CCW

COIL PART NUMBER: 83805

SPRING INFORMATION:

SIZE: 1/8"
PART #: 70616

SPACER INFORMATION:

PART #: 81018

TOE CLAMP PART NUMBER: 70618

MOUNTING FOOT PART NUMBER: 78812

CROSS ARM PART NUMBER: 70425

**RECOMMENDED
QUANTITY**

1 EACH

2 EACH

4 EACH

AS NEEDED

AS NEEDED

ADDITIONAL DRIVE UNIT INFORMATION:

MAY REQUIRE ADDITIONAL SPRINGS FOR TUNING SUCH AS:

1/16"(P/N 70646), AND 3/32"(P/N 70647)

CONTACT MOORFEED FOR PRICING AND AVAILABILITY.

PHONE: (317) 545-7171 FAX: (317) 542-7317 EMAIL: SPARES@MOORFEED.COM

MOORFEED DRIVE UNIT SPARE PARTS LIST

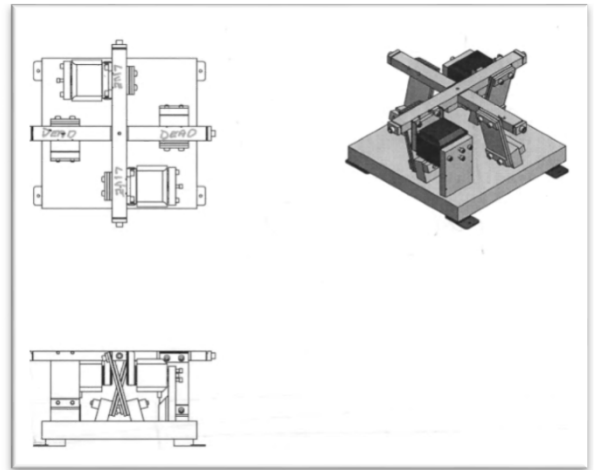

DRIVE UNIT MODEL #

70403

DRIVE UNIT SIZE: 4.5"

DRIVE UNIT VOLTAGE: 220 VAC

DRIVE FREQUENCY: FULL WAVE

NUMBER OF POSTS: 4

DRIVE ROTATION: CW

COIL PART NUMBER: 83705

SPRING INFORMATION:

SIZE: 1/8"
PART #: 70616

SPACER INFORMATION:

PART #: 81018

TOE CLAMP PART NUMBER: 70618

MOUNTING FOOT PART NUMBER: 78812

CROSS ARM PART NUMBER: 70425

**RECOMMENDED
QUANTITY**

1 EACH

2 EACH

4 EACH

AS NEEDED

AS NEEDED

ADDITIONAL DRIVE UNIT INFORMATION:

MAY REQUIRE ADDITIONAL SPRINGS FOR TUNING SUCH AS:

1/16"(P/N 70646) AND 3/32" (P/N 70647)

CONTACT MOORFEED FOR PRICING AND AVAILABILITY.

PHONE: (317) 545-7171 FAX: (317) 542-7317 EMAIL: SPARES@MOORFEED.COM

MOORFEED DRIVE UNIT SPARE PARTS LIST

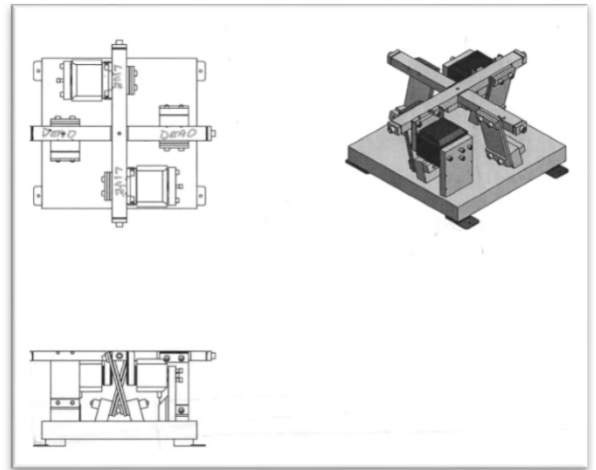

DRIVE UNIT MODEL #

70404

DRIVE UNIT SIZE: 4.5"

DRIVE UNIT VOLTAGE: 220 VAC

DRIVE FREQUENCY: FULL WAVE

NUMBER OF POSTS: 4

DRIVE ROTATION: CCW

COIL PART NUMBER: 83705

SPRING INFORMATION:

SIZE: 1/8"
PART #: 70616

SPACER INFORMATION:

PART #: 81018

TOE CLAMP PART NUMBER: 70618

MOUNTING FOOT PART NUMBER: 78812

CROSS ARM PART NUMBER: 70425

**RECOMMENDED
QUANTITY**

1 EACH

2 EACH

4 EACH

AS NEEDED

AS NEEDED

ADDITIONAL DRIVE UNIT INFORMATION:

MAY REQUIRE ADDITIONAL SPRINGS FOR TUNING SUCH AS:

1/16"(P/N 70646) AND 3/32"(P/N 70616)

CONTACT MOORFEED FOR PRICING AND AVAILABILITY.

PHONE: (317) 545-7171 FAX: (317) 542-7317 EMAIL: SPARES@MOORFEED.COM

MOORFEED DRIVE UNIT SPARE PARTS LIST

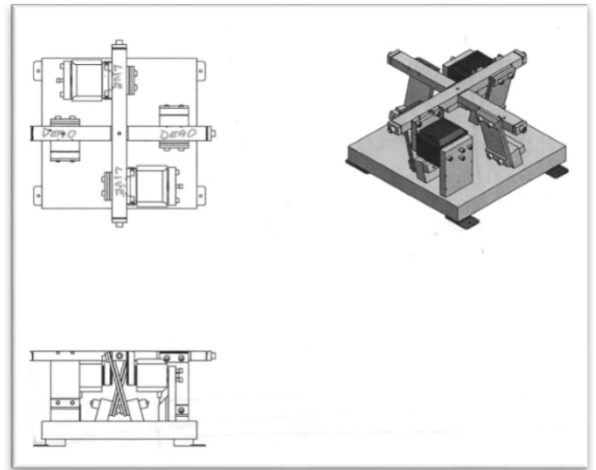

DRIVE UNIT MODEL #

70603

DRIVE UNIT SIZE: 6"

DRIVE UNIT VOLTAGE: 120 VAC

DRIVE FREQUENCY: FULL WAVE

NUMBER OF POSTS: 4

DRIVE ROTATION: CW

COIL PART NUMBER: 83805

SPRING INFORMATION:

SIZE: 1/8"
PART #: 70616

SPACER INFORMATION:

PART #: 81018

TOE CLAMP PART NUMBER: 70618

MOUNTING FOOT PART NUMBER: 78812

CROSS ARM PART NUMBER: 70617

**RECOMMENDED
QUANTITY**

1 EACH

2 EACH

4 EACH

AS NEEDED

AS NEEDED

ADDITIONAL DRIVE UNIT INFORMATION:

MAY REQUIRE ADDITIONAL SPRINGS FOR TUNING SUCH AS:

1/16"(P/N 70646) AND 3/32"(P/N 70647)

CONTACT MOORFEED FOR PRICING AND AVAILABILITY.

PHONE: (317) 545-7171 FAX: (317) 542-7317 EMAIL: SPARES@MOORFEED.COM

MOORFEED DRIVE UNIT SPARE PARTS LIST

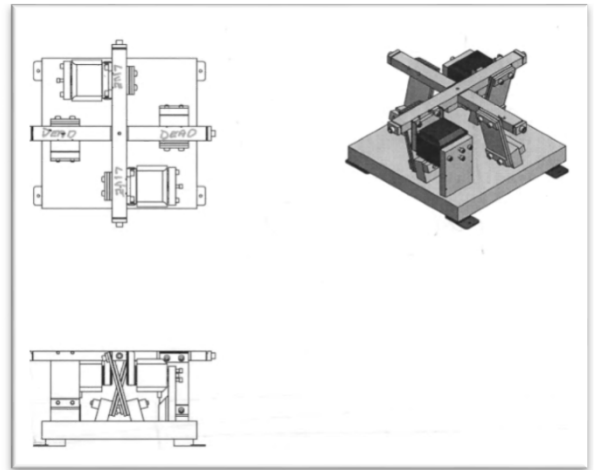

DRIVE UNIT MODEL #

70604

DRIVE UNIT SIZE: 6"

DRIVE UNIT VOLTAGE: 120

DRIVE FREQUENCY: Full Wave

NUMBER OF POSTS: 4

DRIVE ROTATION: CCW

COIL PART NUMBER: 83805

SPRING INFORMATION:

SIZE: 1/8"
PART #: 70616

SPACER INFORMATION:

PART #: 81018

TOE CLAMP PART NUMBER: 70618

MOUNTING FOOT PART NUMBER: 78812

CROSS ARM PART NUMBER: 70625

**RECOMMENDED
QUANTITY**

2 EACH

8 EACH

16 EACH

AS NEEDED

AS NEEDED

ADDITIONAL DRIVE UNIT INFORMATION:

MAY REQUIRE ADDITIONAL SPRINGS FOR TUNING SUCH AS:

1/16"(P/N 70646) AND 3/32" (P/N 70647)

CONTACT MOORFEED FOR PRICING AND AVAILABILITY.

PHONE: (317) 545-7171 FAX: (317) 542-7317 EMAIL: SPARES@MOORFEED.COM

MOORFEED DRIVE UNIT SPARE PARTS LIST

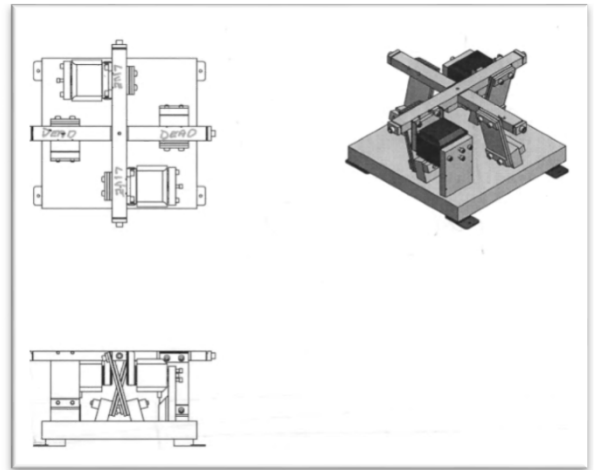

DRIVE UNIT MODEL #

70605

DRIVE UNIT SIZE: 6"

DRIVE UNIT VOLTAGE: 220

DRIVE FREQUENCY: Full Wave

NUMBER OF POSTS: 4

DRIVE ROTATION: CW

COIL PART NUMBER: 83705

SPRING INFORMATION:

SIZE: 1/8"
PART #: 70616

**RECOMMENDED
QUANTITY**

8 EACH

SPACER INFORMATION:

PART #: 81018

16 EACH

TOE CLAMP PART NUMBER: 70618

AS NEEDED

MOUNTING FOOT PART NUMBER: 78812

AS NEEDED

CROSS ARM PART NUMBER: 70617

ADDITIONAL DRIVE UNIT INFORMATION:

MAY REQUIRE ADDITIONAL SPRINGS FOR TUNING SUCH AS:

1/16"(P/N 70646) AND 3/32"(P/N 70647)

CONTACT MOORFEED FOR PRICING AND AVAILABILITY.

PHONE: (317) 545-7171 FAX: (317) 542-7317 EMAIL: SPARES@MOORFEED.COM

MOORFEED DRIVE UNIT SPARE PARTS LIST

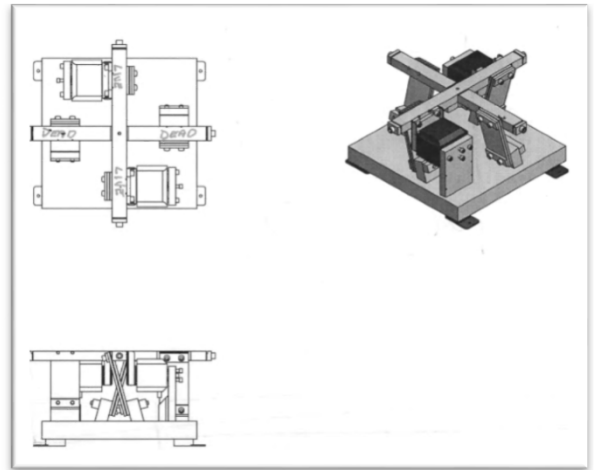

DRIVE UNIT MODEL #

70606

DRIVE UNIT SIZE: 6"

DRIVE UNIT VOLTAGE: 220

DRIVE FREQUENCY: Full Wave

NUMBER OF POSTS: 4

DRIVE ROTATION: CCW

COIL PART NUMBER: 83705

SPRING INFORMATION:

SIZE: 1/8"
PART #: 70616

SPACER INFORMATION:

PART #: 81018

TOE CLAMP PART NUMBER: 70618

MOUNTING FOOT PART NUMBER: 78812

CROSS ARM PART NUMBER: 70625

**RECOMMENDED
QUANTITY**

2 EACH

8 EACH

16 EACH

AS NEEDED

AS NEEDED

ADDITIONAL DRIVE UNIT INFORMATION:

MAY REQUIRE ADDITIONAL SPRING FOR TUNING SUCH AS:

1/16"(P/N 70646) AND 3/32"(P/N 70647)

CONTACT MOORFEED FOR PRICING AND AVAILABILITY.

PHONE: (317) 545-7171 FAX: (317) 542-7317 EMAIL: SPARES@MOORFEED.COM

MOORFEED DRIVE UNIT SPARE PARTS LIST

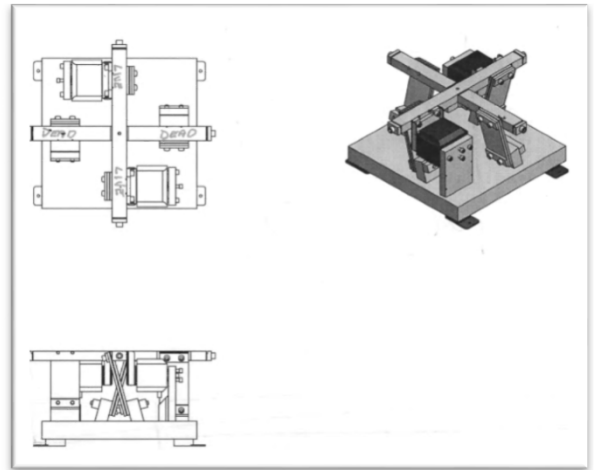

DRIVE UNIT MODEL #

70801

DRIVE UNIT SIZE: 8"

DRIVE UNIT VOLTAGE: 120

DRIVE FREQUENCY: Full Wave

NUMBER OF POSTS: 4

DRIVE ROTATION: CW

COIL PART NUMBER: 83808, 83809

SPRING INFORMATION:

SIZE: 1/8"
PART #: 70616

SPACER INFORMATION:

PART #: 70827, UPPER
70822, LOWER

TOE CLAMP PART NUMBER: 70818

MOUNTING FOOT PART NUMBER: 78812

CROSS ARM PART NUMBER: 70817

**RECOMMENDED
QUANTITY**

2 EACH

8 EACH

16 EACH

16 EACH

AS NEEDED

AS NEEDED

ADDITIONAL DRIVE UNIT INFORMATION:

MAY REQUIRE ADDITIONAL SPRINGS FOR TUNING SUCH AS:

1/16"(P/N 70815)

CONTACT MOORFEED FOR PRICING AND AVAILABILITY.

PHONE: (317) 545-7171 FAX: (317) 542-7317 EMAIL: SPARES@MOORFEED.COM

MOORFEED DRIVE UNIT SPARE PARTS LIST

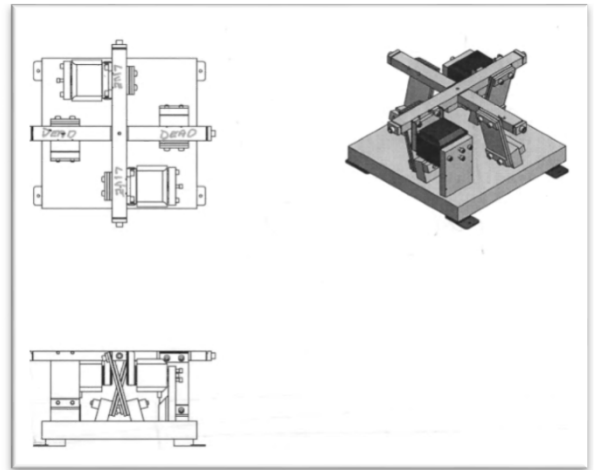

DRIVE UNIT MODEL #

70802

DRIVE UNIT SIZE: 8"

DRIVE UNIT VOLTAGE: 120 VAC

DRIVE FREQUENCY: FULL WAVE

NUMBER OF POSTS: 4

DRIVE ROTATION: CCW

COIL PART NUMBER: 83808 & 83809

SPRING INFORMATION:

SIZE: 1/8"
PART #: 70816

SPACER INFORMATION:

PART #: 70827, UPPER
70822, LOWER

TOE CLAMP PART NUMBER: 70818

MOUNTING FOOT PART NUMBER: 78812

CROSS ARM PART NUMBER: 70825

**RECOMMENDED
QUANTITY**

1 EACH

4 EACH

4 EACH

4 EACH

AS NEEDED

AS NEEDED

ADDITIONAL DRIVE UNIT INFORMATION:

MAY REQUIRE ADDITIONAL SPRINGS FOR TUNING SUCH AS:

1/16"(P/N 70815)

CONTACT MOORFEED FOR PRICING AND AVAILABILITY.

PHONE: (317) 545-7171 FAX: (317) 542-7317 EMAIL: SPARES@MOORFEED.COM

MOORFEED DRIVE UNIT SPARE PARTS LIST

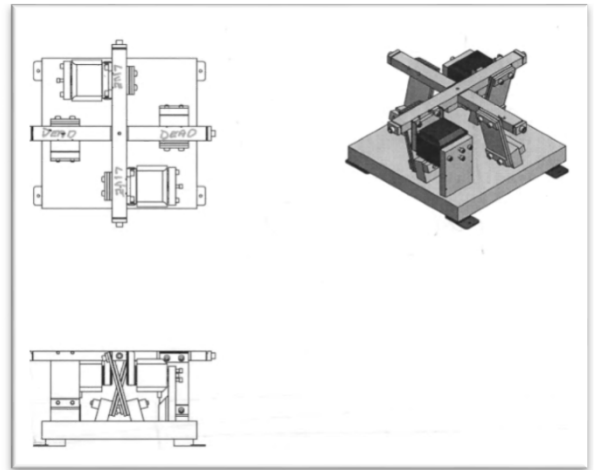

DRIVE UNIT MODEL #

70803

DRIVE UNIT SIZE: 8"

DRIVE UNIT VOLTAGE: 220

DRIVE FREQUENCY: Full Wave

NUMBER OF POSTS: 4

DRIVE ROTATION: CW

COIL PART NUMBER: 83708, 83709

SPRING INFORMATION:

SIZE: 1/8"
PART #: 70616

SPACER INFORMATION:

PART #: 70827, UPPER
70822, LOWER

TOE CLAMP PART NUMBER: 70818

MOUNTING FOOT PART NUMBER: 78812

CROSS ARM PART NUMBER: 70817

**RECOMMENDED
QUANTITY**

2 EACH

8 EACH

8 EACH

8 EACH

AS NEEDED

AS NEEDED

ADDITIONAL DRIVE UNIT INFORMATION:

MAY REQUIRE ADDITIONAL SPRINGS FOR TUNING SUCH AS:

1/16" (P/N 70815)

CONTACT MOORFEED FOR PRICING AND AVAILABILITY.

PHONE: (317) 545-7171 FAX: (317) 542-7317 EMAIL: SPARES@MOORFEED.COM

MOORFEED DRIVE UNIT SPARE PARTS LIST

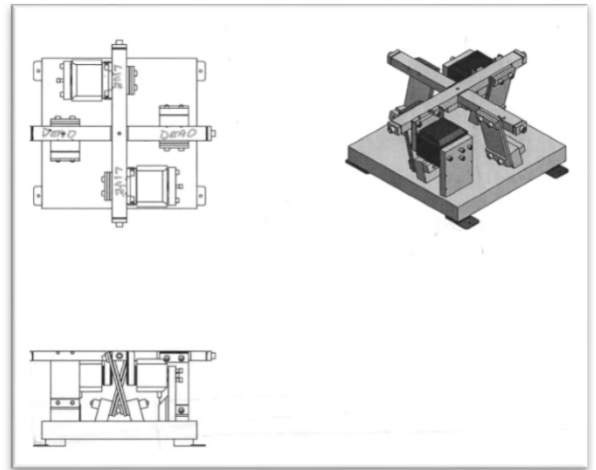

DRIVE UNIT MODEL #

70804

DRIVE UNIT SIZE: 8"

DRIVE UNIT VOLTAGE: 220

DRIVE FREQUENCY: Full Wave

NUMBER OF POSTS: 4

DRIVE ROTATION: CCW

COIL PART NUMBER: 83708, 83709

SPRING INFORMATION:

SIZE: 1/8"
PART #: 70616

SPACER INFORMATION:

PART #: 70827, UPPER
70822, LOWER

TOE CLAMP PART NUMBER: 70818

MOUNTING FOOT PART NUMBER: 78812

CROSS ARM PART NUMBER: 70825

**RECOMMENDED
QUANTITY**

2 EACH

8 EACH

8 EACH

8 EACH

AS NEEDED

AS NEEDED

ADDITIONAL DRIVE UNIT INFORMATION:

MAY REQUIRE ADDITIONAL SPRINGS FOR TUNING SUCH AS:

1-16" (P/N 70815)

CONTACT MOORFEED FOR PRICING AND AVAILABILITY.

PHONE: (317) 545-7171 FAX: (317) 542-7317 EMAIL: SPARES@MOORFEED.COM

MOORFEED DRIVE UNIT SPARE PARTS LIST

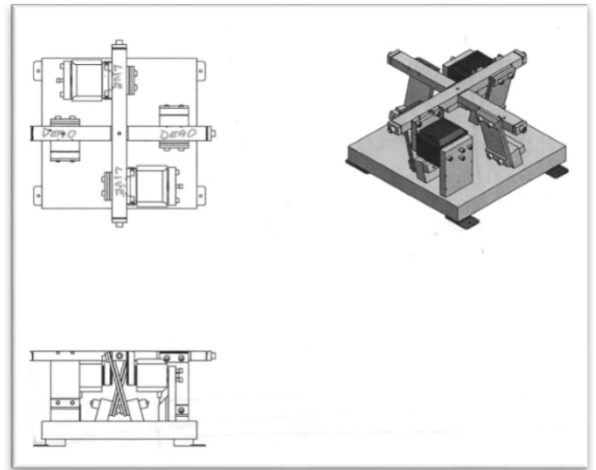

DRIVE UNIT MODEL #

71003

DRIVE UNIT SIZE: 10"

DRIVE UNIT VOLTAGE: 120

DRIVE FREQUENCY: Full Wave

NUMBER OF POSTS: 4

DRIVE ROTATION: CW

COIL PART NUMBER: 83810

SPRING INFORMATION:

SIZE: 1/4"
PART #: 71045

SPACER INFORMATION:

PART #: 70827, UPPER
70822, LOWER

TOE CLAMP PART NUMBER: 70818

MOUNTING FOOT PART NUMBER: 71012

CROSS ARM PART NUMBER: 71017

**RECOMMENDED
QUANTITY**

2 EACH

8 EACH

8 EACH

8 EACH

AS NEEDED

AS NEEDED

ADDITIONAL DRIVE UNIT INFORMATION:

MAY REQUIRE ADDITIONAL SPRINGS FOR TUNING SUCH AS:

3/16" (P/N 71048) AND 5/16"(P/N 71049)

CONTACT MOORFEED FOR PRICING AND AVAILABILITY.

PHONE: (317) 545-7171 FAX: (317) 542-7317 EMAIL: SPARES@MOORFEED.COM

MOORFEED DRIVE UNIT SPARE PARTS LIST

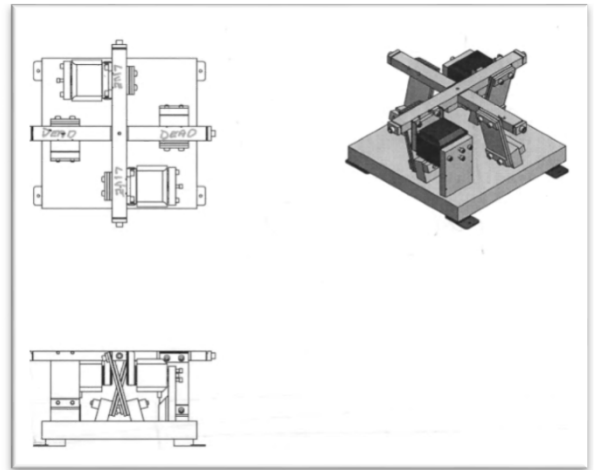

DRIVE UNIT MODEL #

71004

DRIVE UNIT SIZE: 10"

DRIVE UNIT VOLTAGE: 120

DRIVE FREQUENCY: Full Wave

NUMBER OF POSTS: 4

DRIVE ROTATION: CCW

COIL PART NUMBER: 83810

SPRING INFORMATION:

SIZE: 1/4"
PART #: 71045

SPACER INFORMATION:

PART #: 70827, UPPER
70822, LOWER

TOE CLAMP PART NUMBER: 70818

MOUNTING FOOT PART NUMBER: 71012

CROSS ARM PART NUMBER: 71025

**RECOMMENDED
QUANTITY**

2 EACH

8 EACH

8 EACH

8 EACH

AS NEEDED

AS NEEDED

ADDITIONAL DRIVE UNIT INFORMATION:

MAY REQUIRE ADDITIONAL SPRINGS FOR TUNING SUCH AS:

3/16"(P/N 71048) AND 5/16"(P/N 71049)

CONTACT MOORFEED FOR PRICING AND AVAILABILITY.

PHONE: (317) 545-7171 FAX: (317) 542-7317 EMAIL: SPARES@MOORFEED.COM

MOORFEED DRIVE UNIT SPARE PARTS LIST

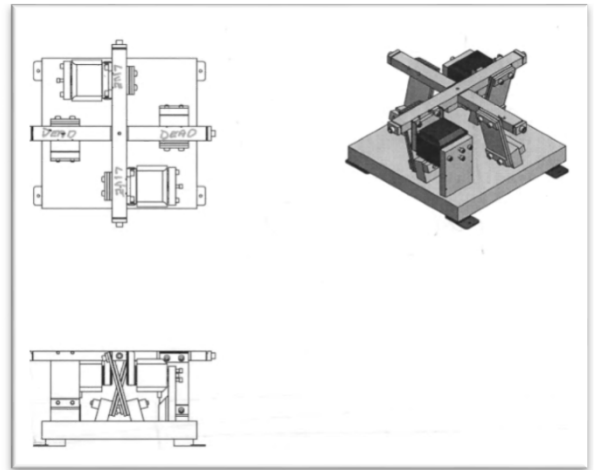

DRIVE UNIT MODEL #

71005

DRIVE UNIT SIZE: 10"

DRIVE UNIT VOLTAGE: 220

DRIVE FREQUENCY: Full Wave

NUMBER OF POSTS: 4

DRIVE ROTATION: CW

COIL PART NUMBER: 83710

SPRING INFORMATION:

SIZE: 1/4"
PART #: 71045

SPACER INFORMATION:

PART #: 70827, UPPER
70822, LOWER

TOE CLAMP PART NUMBER: 70818

MOUNTING FOOT PART NUMBER: 71012

CROSS ARM PART NUMBER: 71017

**RECOMMENDED
QUANTITY**

2 EACH

8 EACH

8 EACH

8 EACH

AS NEEDED

AS NEEDED

ADDITIONAL DRIVE UNIT INFORMATION:

MAY REQUIRE ADDITIONAL SPRINGS FOR TUNING SUCH AS:

3/16"(P/N 71048) AND 5/16"(P/N71049)

CONTACT MOORFEED FOR PRICING AND AVAILABILITY.

PHONE: (317) 545-7171 FAX: (317) 542-7317 EMAIL: SPARES@MOORFEED.COM

MOORFEED DRIVE UNIT SPARE PARTS LIST

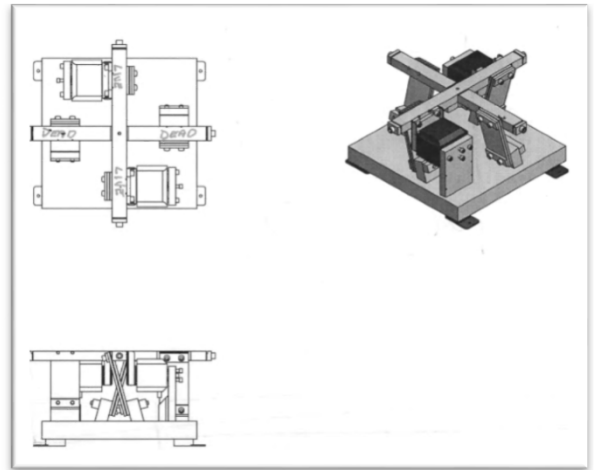

DRIVE UNIT MODEL #

71006

DRIVE UNIT SIZE: 10"

DRIVE UNIT VOLTAGE: 220

DRIVE FREQUENCY: Full Wave

NUMBER OF POSTS: 4

DRIVE ROTATION: CCW

COIL PART NUMBER: 83710

SPRING INFORMATION:

SIZE: 1/4"
PART #: 71045

SPACER INFORMATION:

PART #: 70827, UPPER
70822, LOWER

TOE CLAMP PART NUMBER: 70818

MOUNTING FOOT PART NUMBER: 71012

CROSS ARM PART NUMBER: 71025

**RECOMMENDED
QUANTITY**

2 EACH

8 EACH

8 EACH

8 EACH

AS NEEDED

AS NEEDED

ADDITIONAL DRIVE UNIT INFORMATION:

MAY REQUIRE ADDITIONAL SPRINGS FOR TUNING SUCH AS:

3/16"(P/N 71048) AND 5/16"(P/N 71049)

CONTACT MOORFEED FOR PRICING AND AVAILABILITY.

PHONE: (317) 545-7171 FAX: (317) 542-7317 EMAIL: SPARES@MOORFEED.COM

MOORFEED DRIVE UNIT SPARE PARTS LIST

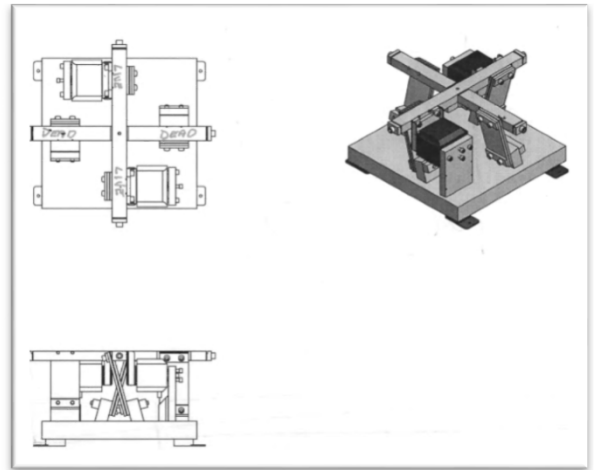

DRIVE UNIT MODEL #

71203

DRIVE UNIT SIZE: 12"

DRIVE UNIT VOLTAGE: 120

DRIVE FREQUENCY: Full Wave

NUMBER OF POSTS: 4

DRIVE ROTATION: CW

COIL PART NUMBER: 83810

SPRING INFORMATION:

SIZE: 1/4"
PART #: 71045

SPACER INFORMATION:

PART #: 70827, UPPER
70822, LOWER

TOE CLAMP PART NUMBER: 70818

MOUNTING FOOT PART NUMBER: 71012

CROSS ARM PART NUMBER: 71217

**RECOMMENDED
QUANTITY**

2 EACH

8 EACH

8 EACH

8 EACH

AS NEEDED

AS NEEDED

ADDITIONAL DRIVE UNIT INFORMATION:

MAY REQUIRE ADDITIONAL SPRINGS FOR TUNING SUCH AS:

3/16"(P/N 71048) AND 5/16"(P/N 71049)

CONTACT MOORFEED FOR PRICING AND AVAILABILITY.

PHONE: (317) 545-7171 FAX: (317) 542-7317 EMAIL: SPARES@MOORFEED.COM

MOORFEED DRIVE UNIT SPARE PARTS LIST

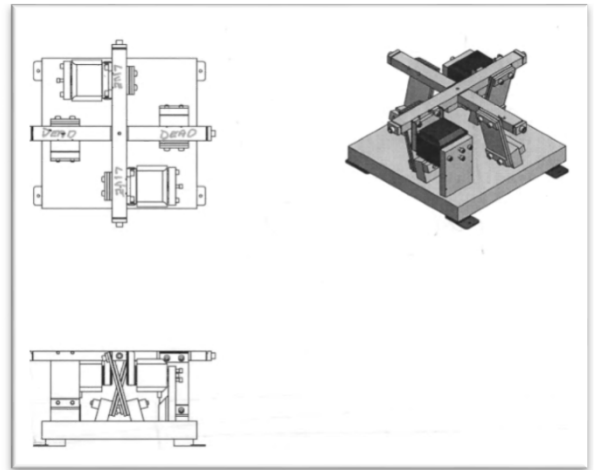

DRIVE UNIT MODEL #

71204

DRIVE UNIT SIZE: 12"

DRIVE UNIT VOLTAGE: 120 VAC

DRIVE FREQUENCY: FULL WAVE

NUMBER OF POSTS: 4

DRIVE ROTATION: CCW

COIL PART NUMBER: 83810

SPRING INFORMATION:

SIZE: 5/16"

PART #: 71049

SIZE: 1/4"

PART #: 71045

SPACER INFORMATION:

PART #: 70827, UPPER

70822, LOWER

TOE CLAMP PART NUMBER: 70818

MOUNTING FOOT PART NUMBER: 71012

CROSS ARM PART NUMBER: 71225

**RECOMMENDED
QUANTITY**

1 EACH

4 EACH

4 EACH

8 EACH

8 EACH

AS NEEDED

AS NEEDED

ADDITIONAL DRIVE UNIT INFORMATION:

MAY REQUIRE ADDITIONAL SPRINGS FOR TUNING SUCH AS:

3/16"(P/N 71048) AND 5/16"(P/N 71049)

CONTACT MOORFEED FOR PRICING AND AVAILABILITY.

PHONE: (317) 545-7171 FAX: (317) 542-7317 EMAIL: SPARES@MOORFEED.COM

MOORFEED DRIVE UNIT SPARE PARTS LIST

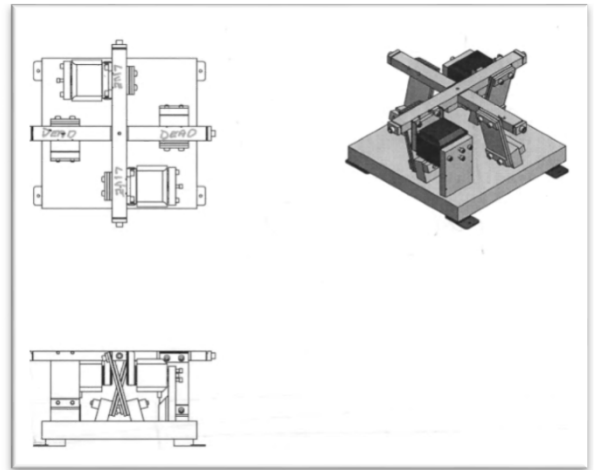

DRIVE UNIT MODEL #

71205

DRIVE UNIT SIZE: 12"

DRIVE UNIT VOLTAGE: 220

DRIVE FREQUENCY: Full Wave

NUMBER OF POSTS: 4

DRIVE ROTATION: CW

COIL PART NUMBER: 83710

SPRING INFORMATION:

SIZE: 1/4"
PART #: 71045

SPACER INFORMATION:

PART #: 70827, UPPER
70822, LOWER

TOE CLAMP PART NUMBER: 70818

MOUNTING FOOT PART NUMBER: 71012

CROSS ARM PART NUMBER: 71217

**RECOMMENDED
QUANTITY**

2 EACH

8 EACH

8 EACH

8 EACH

AS NEEDED

AS NEEDED

ADDITIONAL DRIVE UNIT INFORMATION:

MAY REQUIRE ADDITIONAL SPRINGS FOR TUNING SUCH AS:

3/16"(P/N 71048) AND 5/16"(P/N 71049)

CONTACT MOORFEED FOR PRICING AND AVAILABILITY.

PHONE: (317) 545-7171 FAX: (317) 542-7317 EMAIL: SPARES@MOORFEED.COM

MOORFEED DRIVE UNIT SPARE PARTS LIST

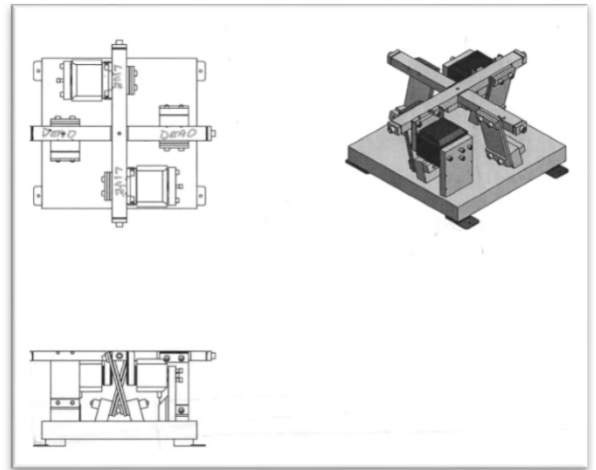

DRIVE UNIT MODEL #

71206

DRIVE UNIT SIZE: 12"

DRIVE UNIT VOLTAGE: 220

DRIVE FREQUENCY: Full Wave

NUMBER OF POSTS: 4

DRIVE ROTATION: CCW

COIL PART NUMBER: 83710

SPRING INFORMATION:

SIZE: 1/4"
PART #: 71045

SPACER INFORMATION:

PART #: 70827, UPPER
70822, LOWER

TOE CLAMP PART NUMBER: 70818

MOUNTING FOOT PART NUMBER: 71012

CROSS ARM PART NUMBER: 71225

**RECOMMENDED
QUANTITY**

2 EACH

8 EACH

8 EACH

8 EACH

AS NEEDED

AS NEEDED

ADDITIONAL DRIVE UNIT INFORMATION:

MAY REQUIRE ADDITIONAL SPRINGS FOR TUNING SUCH AS:

3/16"(P/N 71048) AND 5/16"(P/N 71049)

CONTACT MOORFEED FOR PRICING AND AVAILABILITY.

PHONE: (317) 545-7171 FAX: (317) 542-7317 EMAIL: SPARES@MOORFEED.COM

MOORFEED DRIVE UNIT SPARE PARTS LIST

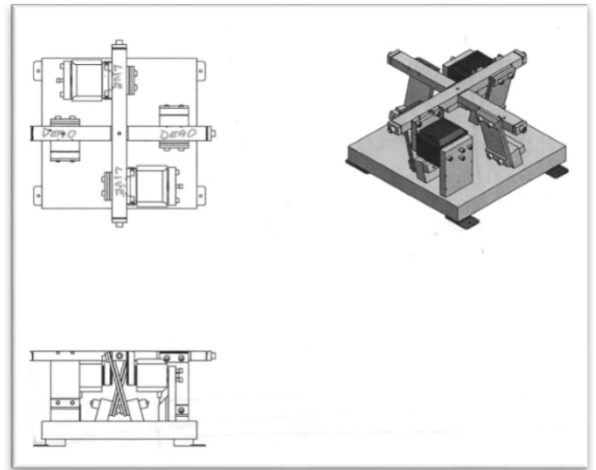

DRIVE UNIT MODEL #

71503

DRIVE UNIT SIZE: 15"

DRIVE UNIT VOLTAGE: 120

DRIVE FREQUENCY: Full Wave

NUMBER OF POSTS: 4

DRIVE ROTATION: CW

COIL PART NUMBER: 83815

SPRING INFORMATION:

SIZE: 1/4"
PART #: 71545

SPACER INFORMATION:

PART #: 71527, UPPER
71522, LOWER

TOE CLAMP PART NUMBER: 70818

MOUNTING FOOT PART NUMBER: 71012

CROSS ARM PART NUMBER: 71517

**RECOMMENDED
QUANTITY**

2 EACH

8 EACH

8 EACH

8 EACH

AS NEEDED

AS NEEDED

ADDITIONAL DRIVE UNIT INFORMATION:

MAY REQUIRE ADDITIONAL SPRINGS FOR TUNING SUCH AS:

3/16"(P/N 71548) AND 5/16"(P/N 71549)

CONTACT MOORFEED FOR PRICING AND AVAILABILITY.

PHONE: (317) 545-7171 FAX: (317) 542-7317 EMAIL: SPARES@MOORFEED.COM

MOORFEED DRIVE UNIT SPARE PARTS LIST

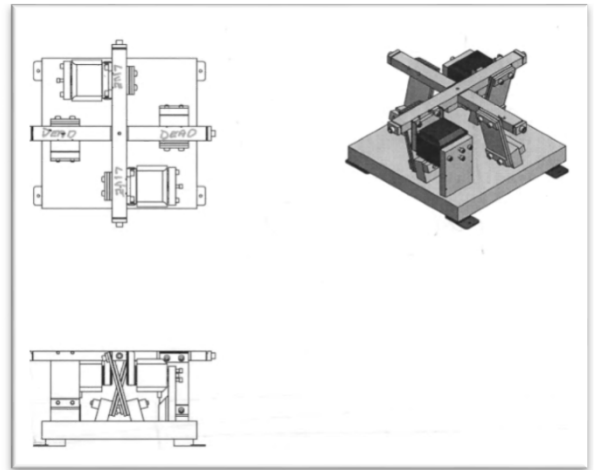

DRIVE UNIT MODEL #

71504

DRIVE UNIT SIZE: 15"

DRIVE UNIT VOLTAGE: 120

DRIVE FREQUENCY: Full Wave

NUMBER OF POSTS: 4

DRIVE ROTATION: CCW

COIL PART NUMBER: 83815

SPRING INFORMATION:

SIZE: 1/4"
PART #: 71545

SPACER INFORMATION:

PART #: 71527, UPPER
71522, LOWER

TOE CLAMP PART NUMBER: 70818

MOUNTING FOOT PART NUMBER: 71012

CROSS ARM PART NUMBER: 71525

**RECOMMENDED
QUANTITY**

2 EACH

8 EACH

8 EACH

8 EACH

AS NEEDED

AS NEEDED

ADDITIONAL DRIVE UNIT INFORMATION:

MAY REQUIRE ADDITIONAL SPRINGS FOR TUNING SUCH AS:

3/16"(P/N 71548) AND 5/16"(P/N 71549)

CONTACT MOORFEED FOR PRICING AND AVAILABILITY.

PHONE: (317) 545-7171 FAX: (317) 542-7317 EMAIL: SPARES@MOORFEED.COM

MOORFEED DRIVE UNIT SPARE PARTS LIST

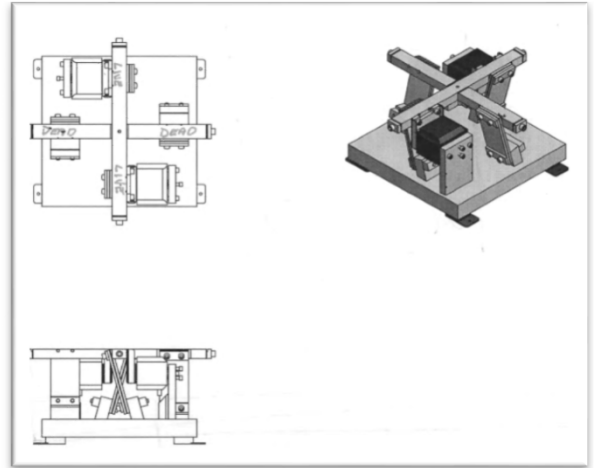

DRIVE UNIT MODEL #

71505

DRIVE UNIT SIZE: 15"

DRIVE UNIT VOLTAGE: 220

DRIVE FREQUENCY: Full Wave

NUMBER OF POSTS: 4

DRIVE ROTATION: CW

COIL PART NUMBER: 83715

SPRING INFORMATION:

SIZE: 1/4"
PART #: 71545

SPACER INFORMATION:

PART #: 71527, UPPER
71522, LOWER

TOE CLAMP PART NUMBER: 70818

MOUNTING FOOT PART NUMBER: 71012

CROSS ARM PART NUMBER: 71517

**RECOMMENDED
QUANTITY**

2 EACH

8 EACH

8 EACH

8 EACH

AS NEEDED

AS NEEDED

ADDITIONAL DRIVE UNIT INFORMATION:

MAY REQUIRE ADDITIONAL SPRINGS FOR TUNING SUCH AS:

3/16"(P/N 71548) AND 5/16"(P/N 71549)

CONTACT MOORFEED FOR PRICING AND AVAILABILITY.

PHONE: (317) 545-7171 FAX: (317) 542-7317 EMAIL: SPARES@MOORFEED.COM

MOORFEED DRIVE UNIT SPARE PARTS LIST

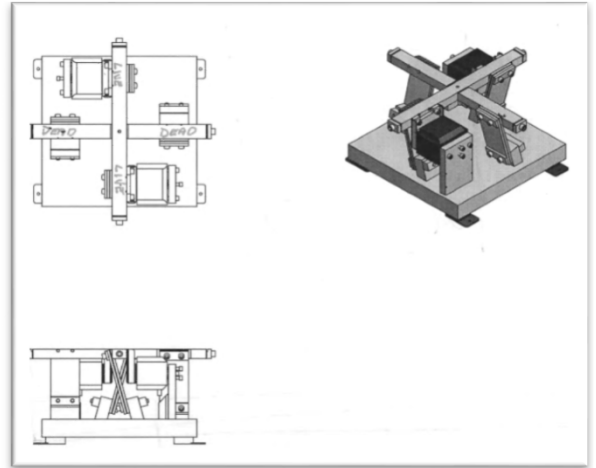

DRIVE UNIT MODEL #

71506

DRIVE UNIT SIZE: 15"

DRIVE UNIT VOLTAGE: 220

DRIVE FREQUENCY: Full Wave

NUMBER OF POSTS: 4

DRIVE ROTATION: CCW

COIL PART NUMBER: 83715

SPRING INFORMATION:

SIZE: 1/4"
PART #: 71545

SPACER INFORMATION:

PART #: 71527, UPPER
71522, LOWER

TOE CLAMP PART NUMBER: 70818

MOUNTING FOOT PART NUMBER: 71012

CROSS ARM PART NUMBER: 71517

**RECOMMENDED
QUANTITY**

2 EACH

8 EACH

8 EACH

8 EACH

AS NEEDED

AS NEEDED

ADDITIONAL DRIVE UNIT INFORMATION:

MAY REQUIRE ADDITIONAL SPRINGS FOR TUNING SUCH AS:

3/16"(P/N 71548) AND 5/16"(P/N 71549)

CONTACT MOORFEED FOR PRICING AND AVAILABILITY.

PHONE: (317) 545-7171 FAX: (317) 542-7317 EMAIL: SPARES@MOORFEED.COM

MOORFEED DRIVE UNIT SPARE PARTS LIST

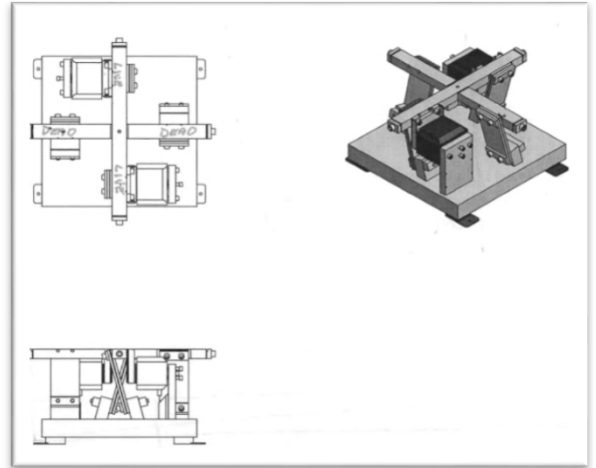

DRIVE UNIT MODEL #

71803

DRIVE UNIT SIZE: 18"

DRIVE UNIT VOLTAGE: 120

DRIVE FREQUENCY: Full Wave

NUMBER OF POSTS: 4

DRIVE ROTATION: CW

COIL PART NUMBER: 83815

SPRING INFORMATION:

SIZE: 1/4"
PART #: 71845

SPACER INFORMATION:

PART #: 71822

TOE CLAMP PART NUMBER: 71818

MOUNTING FOOT PART NUMBER: 71012

CROSS ARM PART NUMBER: 71817

**RECOMMENDED
QUANTITY**

2 EACH

8 EACH

16 EACH

AS NEEDED

AS NEEDED

ADDITIONAL DRIVE UNIT INFORMATION:

MAY REQUIRE ADDITIONAL SPRINGS FOR TUNING SUCH AS:

3/16"(P/N 71848) AND 5/16"(P/N 71849)

CONTACT MOORFEED FOR PRICING AND AVAILABILITY.

PHONE: (317) 545-7171 FAX: (317) 542-7317 EMAIL: SPARES@MOORFEED.COM

MOORFEED DRIVE UNIT SPARE PARTS LIST

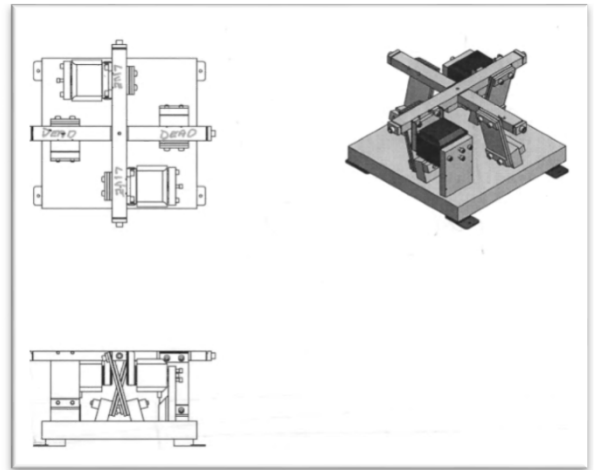

DRIVE UNIT MODEL #

71804

DRIVE UNIT SIZE: 18"

DRIVE UNIT VOLTAGE: 120

DRIVE FREQUENCY: Full Wave

NUMBER OF POSTS: 4

DRIVE ROTATION: CCW

COIL PART NUMBER: 83815

SPRING INFORMATION:

SIZE: 1/4"
PART #: 71845

SPACER INFORMATION:

PART #: 71822

TOE CLAMP PART NUMBER: 71818

MOUNTING FOOT PART NUMBER: 71012

CROSS ARM PART NUMBER: 71825

**RECOMMENDED
QUANTITY**

2 EACH

8 EACH

16 EACH

AS NEEDED

AS NEEDED

ADDITIONAL DRIVE UNIT INFORMATION:

MAY REQUIRE ADDITIONAL SPRINGS FOR TUNING SUCH AS:

3/16" (P/N 71848) & 5/16" (P/N 71849)

CONTACT MOORFEED FOR PRICING AND AVAILABILITY.

PHONE: (317) 545-7171 FAX: (317) 542-7317 EMAIL: SPARES@MOORFEED.COM

MOORFEED DRIVE UNIT SPARE PARTS LIST

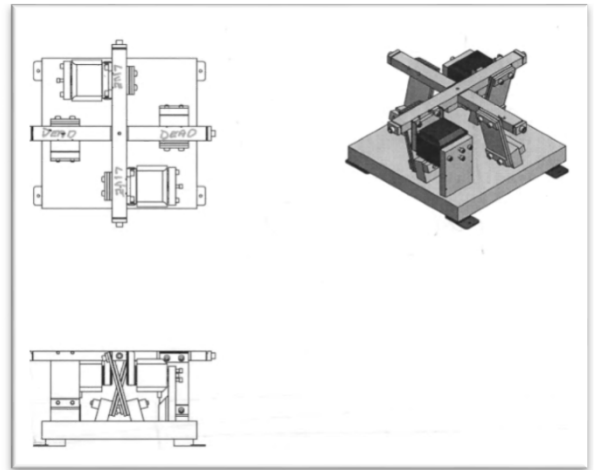

DRIVE UNIT MODEL #

71805

DRIVE UNIT SIZE: 18"

DRIVE UNIT VOLTAGE: 220

DRIVE FREQUENCY: Full Wave

NUMBER OF POSTS: 4

DRIVE ROTATION: CW

COIL PART NUMBER: 83715

SPRING INFORMATION:

SIZE: 1/4"
PART #: 71845

SPACER INFORMATION:

PART #: 71822

TOE CLAMP PART NUMBER: 71818

MOUNTING FOOT PART NUMBER: 71012

CROSS ARM PART NUMBER: 71817

**RECOMMENDED
QUANTITY**

2 EACH

8 EACH

16 EACH

AS NEEDED

AS NEEDED

ADDITIONAL DRIVE UNIT INFORMATION:

MAY REQUIRE ADDITIONAL SPRINGS FOR TUNING SUCH AS:

3/16" (P/N 71848) AND 5/16" (P/N 71849)

CONTACT MOORFEED FOR PRICING AND AVAILABILITY.

PHONE: (317) 545-7171 FAX: (317) 542-7317 EMAIL: SPARES@MOORFEED.COM

MOORFEED DRIVE UNIT SPARE PARTS LIST

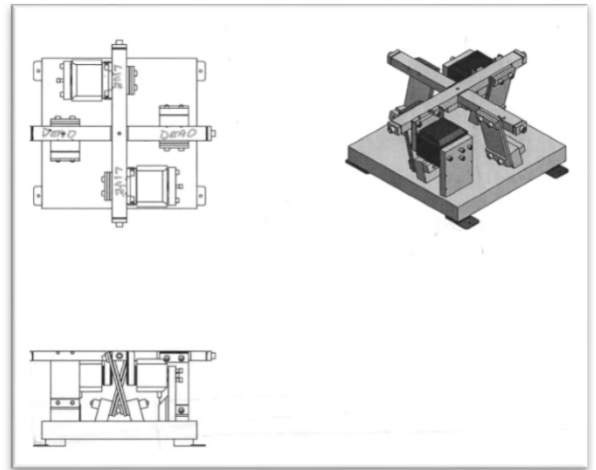

DRIVE UNIT MODEL #

71806

DRIVE UNIT SIZE: 18"

DRIVE UNIT VOLTAGE: 220

DRIVE FREQUENCY: Full Wave

NUMBER OF POSTS: 4

DRIVE ROTATION: CCW

COIL PART NUMBER: 83715

SPRING INFORMATION:

SIZE: 1/4"
PART #: 71845

SPACER INFORMATION:

PART #: 71822

TOE CLAMP PART NUMBER: 71818

MOUNTING FOOT PART NUMBER: 71012

CROSS ARM PART NUMBER: 71825

**RECOMMENDED
QUANTITY**

2 EACH

8 EACH

16 EACH

AS NEEDED

AS NEEDED

ADDITIONAL DRIVE UNIT INFORMATION:

MAY REQUIRE ADDITIONAL SPRING FOR TUNING SUCH AS:

3/16"(P/N 71848) AND 5/16"(P/N 71849)

CONTACT MOORFEED FOR PRICING AND AVAILABILITY.

PHONE: (317) 545-7171 FAX: (317) 542-7317 EMAIL: SPARES@MOORFEED.COM

MOORFEED DRIVE UNIT SPARE PARTS LIST

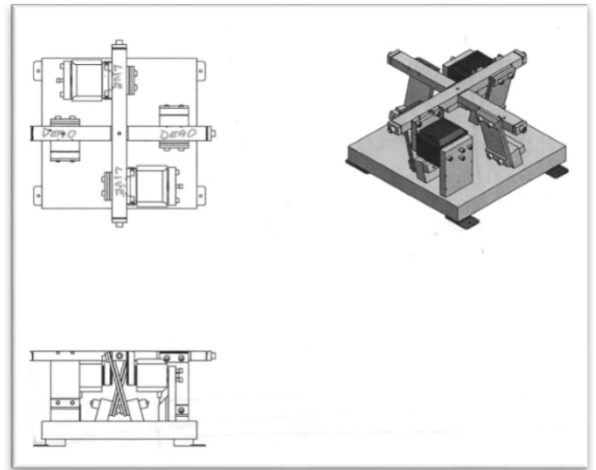

DRIVE UNIT MODEL #

72127

DRIVE UNIT SIZE: 21"

DRIVE UNIT VOLTAGE: 120

DRIVE FREQUENCY: Full Wave

NUMBER OF POSTS: 4

DRIVE ROTATION: CW

COIL PART NUMBER: 83821

SPRING INFORMATION:

SIZE: 1/4"
PART #: 73745

SPACER INFORMATION:

PART #: 73722

TOE CLAMP PART NUMBER: 73718

MOUNTING FOOT PART NUMBER: 72112

CROSS ARM PART NUMBER: 72160

**RECOMMENDED
QUANTITY**

2 EACH

8 EACH

16 EACH

AS NEEDED

AS NEEDED

ADDITIONAL DRIVE UNIT INFORMATION:

MAY REQUIRE ADDITIONAL SPRING FOR TUNING SUCH AS:

1/8"(P/N 73716) AND 3/16"(P/N 73730) AND 3/8"(P/N 73750)

CONTACT MOORFEED FOR PRICING AND AVAILABILITY.

PHONE: (317) 545-7171 FAX: (317) 542-7317 EMAIL: SPARES@MOORFEED.COM

MOORFEED DRIVE UNIT SPARE PARTS LIST

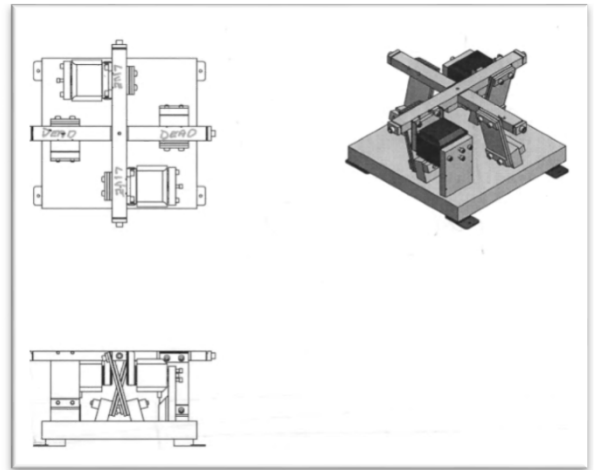

DRIVE UNIT MODEL #

72128

DRIVE UNIT SIZE: 21"

DRIVE UNIT VOLTAGE: 120

DRIVE FREQUENCY: Full Wave

NUMBER OF POSTS: 4

DRIVE ROTATION: CCW

COIL PART NUMBER: 83821

SPRING INFORMATION:

SIZE: 1/4"
PART #: 73745

SPACER INFORMATION:

PART #: 73722

TOE CLAMP PART NUMBER: 73718

MOUNTING FOOT PART NUMBER: 72112

CROSS ARM PART NUMBER: 72161

**RECOMMENDED
QUANTITY**

2 EACH

8 EACH

16 EACH

AS NEEDED

AS NEEDED

ADDITIONAL DRIVE UNIT INFORMATION:

MAY REQUIRE ADDITIONAL SPRINGS FOR TUNING SUCH AS:

1/8"(P/N 73716) AND 3/16"(P/N 73730) AND 3/8"(P/N 73750)

CONTACT MOORFEED FOR PRICING AND AVAILABILITY.

PHONE: (317) 545-7171 FAX: (317) 542-7317 EMAIL: SPARES@MOORFEED.COM

MOORFEED DRIVE UNIT SPARE PARTS LIST

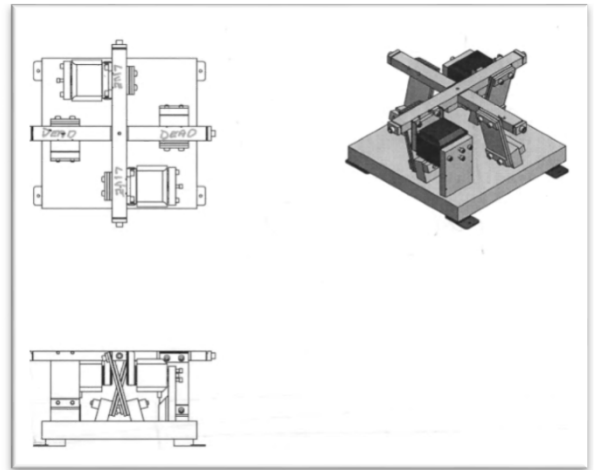

DRIVE UNIT MODEL #

72132

DRIVE UNIT SIZE: 21"

DRIVE UNIT VOLTAGE: 220

DRIVE FREQUENCY: Full wave

NUMBER OF POSTS: 4

DRIVE ROTATION: CW

COIL PART NUMBER: 83721

SPRING INFORMATION:

SIZE: 1/4"
PART #: 73745

SPACER INFORMATION:

PART #: 73722

TOE CLAMP PART NUMBER: 73718

MOUNTING FOOT PART NUMBER: 72112

CROSS ARM PART NUMBER: 72160

**RECOMMENDED
QUANTITY**

2 EACH

8 EACH

16 EACH

AS NEEDED

AS NEEDED

ADDITIONAL DRIVE UNIT INFORMATION:

MAY REQUIRE ADDITIONAL SPRINGS FOR TUNING SUCH AS:

1/8"(P/N 73716) AND 3/16"(P/N 73730) AND 3/8"(P/N 73750)

CONTACT MOORFEED FOR PRICING AND AVAILABILITY.

PHONE: (317) 545-7171 FAX: (317) 542-7317 EMAIL: SPARES@MOORFEED.COM

MOORFEED DRIVE UNIT SPARE PARTS LIST

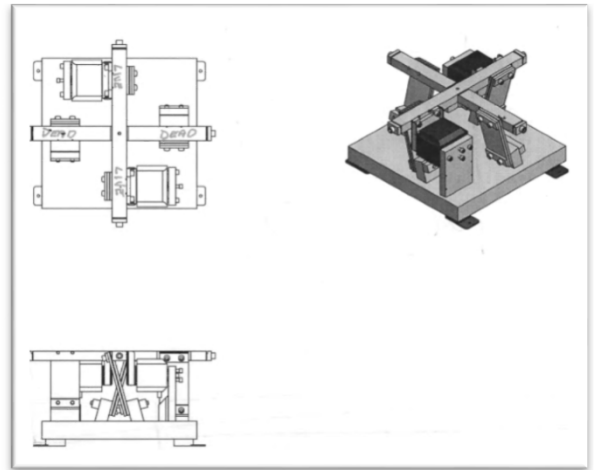

DRIVE UNIT MODEL #

72134

DRIVE UNIT SIZE: 21"

DRIVE UNIT VOLTAGE: 220

DRIVE FREQUENCY: FULL WAVE

NUMBER OF POSTS: 4

DRIVE ROTATION: CCW

COIL PART NUMBER: 83721

SPRING INFORMATION:

SIZE: 1/4"
PART #: 73745

SPACER INFORMATION:

PART #: 73722

TOE CLAMP PART NUMBER: 73718

MOUNTING FOOT PART NUMBER: 72112

CROSS ARM PART NUMBER: 72161

**RECOMMENDED
QUANTITY**

2 EACH

8 EACH

16 EACH

AS NEEDED

AS NEEDED

ADDITIONAL DRIVE UNIT INFORMATION:

MAY REQUIRE ADDITIONAL SPRINGS FOR TUNING SUCH AS:

1/8"(P/N 73716) AND 3/16"(P/N 73730) AND 3/8"(P/N 73750)

CONTACT MOORFEED FOR PRICING AND AVAILABILITY.

PHONE: (317) 545-7171 FAX: (317) 542-7317 EMAIL: SPARES@MOORFEED.COM

MOORFEED DRIVE UNIT SPARE PARTS LIST

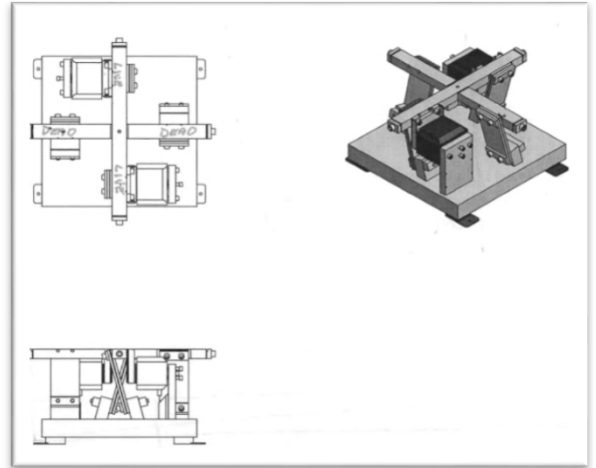

DRIVE UNIT MODEL #

72139

DRIVE UNIT SIZE: 21"

DRIVE UNIT VOLTAGE: 120

DRIVE FREQUENCY: FULL WAVE

NUMBER OF POSTS: 6

DRIVE ROTATION: CW

COIL PART NUMBER: 83821

SPRING INFORMATION:

SIZE: 1/4"
PART #: 73745

SPACER INFORMATION:

PART #: 73722

TOE CLAMP PART NUMBER: 73718

MOUNTING FOOT PART NUMBER: 72112

CROSS ARM PART NUMBER: 72162

**RECOMMENDED
QUANTITY**

2 EACH

8 EACH

16 EACH

AS NEEDED

AS NEEDED

ADDITIONAL DRIVE UNIT INFORMATION:

MAY REQUIRE ADDITIONAL SPRINGS FOR TUNING SUCH AS:

1/8"(P/N 73716) AND 3/16"(P/N 73730) AND 3/8"(P/N 73750)

CONTACT MOORFEED FOR PRICING AND AVAILABILITY.

PHONE: (317) 545-7171 FAX: (317) 542-7317 EMAIL: SPARES@MOORFEED.COM

MOORFEED DRIVE UNIT SPARE PARTS LIST

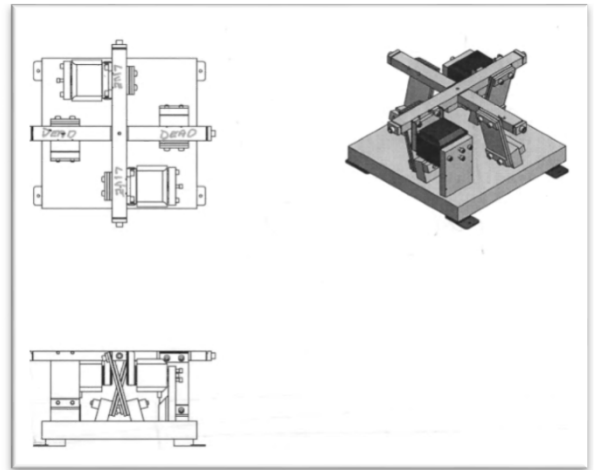

DRIVE UNIT MODEL #

72141

DRIVE UNIT SIZE: 21"

DRIVE UNIT VOLTAGE: 120 VAC

DRIVE FREQUENCY: FULL WAVE

NUMBER OF POSTS: 6

DRIVE ROTATION: CCW

COIL PART NUMBER: 83821

SPRING INFORMATION:

SIZE: 1/4"
PART #: 73745

SPACER INFORMATION:

PART #: 73722

TOE CLAMP PART NUMBER: 73718

MOUNTING FOOT PART NUMBER: 72112

CROSS ARM PART NUMBER: 72163

**RECOMMENDED
QUANTITY**

1 EACH

4 EACH

8 EACH

AS NEEDED

AS NEEDED

ADDITIONAL DRIVE UNIT INFORMATION:

MAY REQUIRE ADDITIONAL SPRINGS FOR TUNING SUCH AS:

1/8"(P/N 73716) AND 3/16"(P/N 73730) AND 3/8"(P/N 73750)

CONTACT MOORFEED FOR PRICING AND AVAILABILITY.

PHONE: (317) 545-7171 FAX: (317) 542-7317 EMAIL: SPARES@MOORFEED.COM

MOORFEED DRIVE UNIT SPARE PARTS LIST

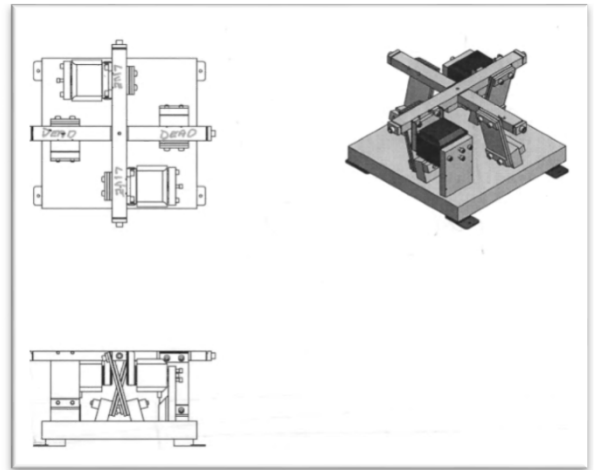

DRIVE UNIT MODEL #

72142

DRIVE UNIT SIZE: 21"

DRIVE UNIT VOLTAGE: 220

DRIVE FREQUENCY: Full Wave

NUMBER OF POSTS: 6

DRIVE ROTATION: CW

COIL PART NUMBER: 83721

SPRING INFORMATION:

SIZE: 1/4"
PART #: 73745

SPACER INFORMATION:

PART #: 73722

TOE CLAMP PART NUMBER: 73718

MOUNTING FOOT PART NUMBER: 72112

CROSS ARM PART NUMBER: 72162

**RECOMMENDED
QUANTITY**

2 EACH

8 EACH

16 EACH

AS NEEDED

AS NEEDED

ADDITIONAL DRIVE UNIT INFORMATION:

MAY REQUIRE ADDITIONAL SPRING FOR TUNING SUCH AS:

1/8"(P/N 73716) AND 3/16"(P/N 73730) AND 3/8"(P/N 73750)

CONTACT MOORFEED FOR PRICING AND AVAILABILITY.

PHONE: (317) 545-7171 FAX: (317) 542-7317 EMAIL: SPARES@MOORFEED.COM

MOORFEED DRIVE UNIT SPARE PARTS LIST

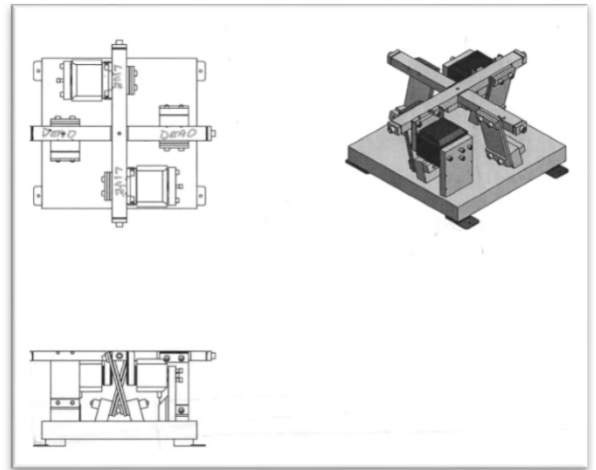

DRIVE UNIT MODEL #

72143

DRIVE UNIT SIZE: 21"

DRIVE UNIT VOLTAGE: 220

DRIVE FREQUENCY: FULL WAVE

NUMBER OF POSTS: 6

DRIVE ROTATION: CCW

COIL PART NUMBER: 83721

SPRING INFORMATION:

SIZE: 1/4"
PART #: 73745

SPACER INFORMATION:

PART #: 73722

TOE CLAMP PART NUMBER: 73718

MOUNTING FOOT PART NUMBER: 72112

CROSS ARM PART NUMBER: 72163

**RECOMMENDED
QUANTITY**

2 EACH

8 EACH

16 EACH

AS NEEDED

AS NEEDED

ADDITIONAL DRIVE UNIT INFORMATION:

MAY REQUIRE ADDITIONAL SPRINGS FOR TUNING SUCH AS:

1/8"(P/N 73716) AND 3/16"(P/N 73730) AND 3/8"(P/N 73750)

CONTACT MOORFEED FOR PRICING AND AVAILABILITY.

PHONE: (317) 545-7171 FAX: (317) 542-7317 EMAIL: SPARES@MOORFEED.COM

MOORFEED DRIVE UNIT SPARE PARTS LIST

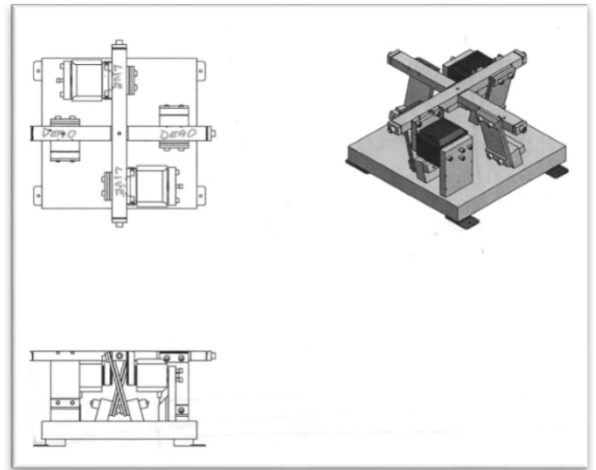

DRIVE UNIT MODEL #

72166

DRIVE UNIT SIZE: 21"

DRIVE UNIT VOLTAGE: 120

DRIVE FREQUENCY: HALF WAVE

NUMBER OF POSTS: 4

DRIVE ROTATION: CW

COIL PART NUMBER: 83821

SPRING INFORMATION:

SIZE: 3/16"
PART #: 73730

SPACER INFORMATION:

PART #: 73722

TOE CLAMP PART NUMBER: 73718

MOUNTING FOOT PART NUMBER: 72112

CROSS ARM PART NUMBER: 72160

**RECOMMENDED
QUANTITY**

2 EACH

8 EACH

16 EACH

AS NEEDED

AS NEEDED

ADDITIONAL DRIVE UNIT INFORMATION:

MAY REQUIRE ADDITIONAL SPRINGS FOR TUNING SUCH AS:

1/8"(P/N 73716) AND 1/4"(P/N 73745) AND 3/8"(P/N 73750)

CONTACT MOORFEED FOR PRICING AND AVAILABILITY.

PHONE: (317) 545-7171 FAX: (317) 542-7317 EMAIL: SPARES@MOORFEED.COM

MOORFEED DRIVE UNIT SPARE PARTS LIST

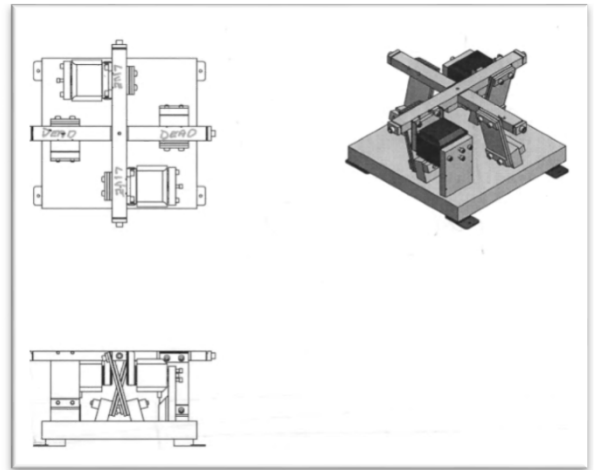

DRIVE UNIT MODEL #

72167

DRIVE UNIT SIZE: 21"

DRIVE UNIT VOLTAGE: 120

DRIVE FREQUENCY: HALF WAVE

NUMBER OF POSTS: 4

DRIVE ROTATION: CCW

COIL PART NUMBER: 83821

SPRING INFORMATION:

SIZE: 3/16"
PART #: 73730

SPACER INFORMATION:

PART #: 73722

TOE CLAMP PART NUMBER: 73718

MOUNTING FOOT PART NUMBER: 72112

CROSS ARM PART NUMBER: 72161

**RECOMMENDED
QUANTITY**

2 EACH

8 EACH

16 EACH

AS NEEDED

AS NEEDED

ADDITIONAL DRIVE UNIT INFORMATION:

MAY REQUIRE ADDITIONAL SPRINGS FOR TUNING SUCH AS:

1/8"(P/N 73716) AND 1/4"(P/N 73745) AND 3/8"(P/N 73750)

CONTACT MOORFEED FOR PRICING AND AVAILABILITY.

PHONE: (317) 545-7171 FAX: (317) 542-7317 EMAIL: SPARES@MOORFEED.COM

MOORFEED DRIVE UNIT SPARE PARTS LIST

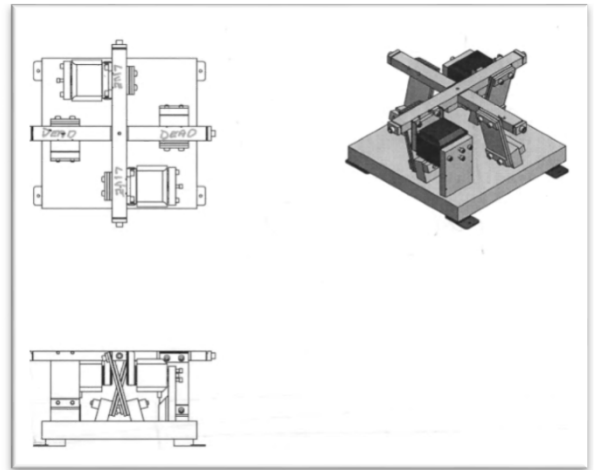

DRIVE UNIT MODEL #

72168

DRIVE UNIT SIZE: 21"

DRIVE UNIT VOLTAGE: 220

DRIVE FREQUENCY: HALF WAVE

NUMBER OF POSTS: 4

DRIVE ROTATION: CW

COIL PART NUMBER: 83721

SPRING INFORMATION:

SIZE: 3/16"
PART #: 73730

SPACER INFORMATION:

PART #: 73722

TOE CLAMP PART NUMBER: 73718

MOUNTING FOOT PART NUMBER: 72112

CROSS ARM PART NUMBER: 72160

**RECOMMENDED
QUANTITY**

2 EACH

8 EACH

16 EACH

AS NEEDED

AS NEEDED

ADDITIONAL DRIVE UNIT INFORMATION:

MAY REQUIRE ADDITIONAL SPRINGS FOR TUNING SUCH AS:

1/8"(P/N 73716) AND 1/4"(P/N 73745) AND 3/8"(P/N 73750)

CONTACT MOORFEED FOR PRICING AND AVAILABILITY.

PHONE: (317) 545-7171 FAX: (317) 542-7317 EMAIL: SPARES@MOORFEED.COM

MOORFEED DRIVE UNIT SPARE PARTS LIST

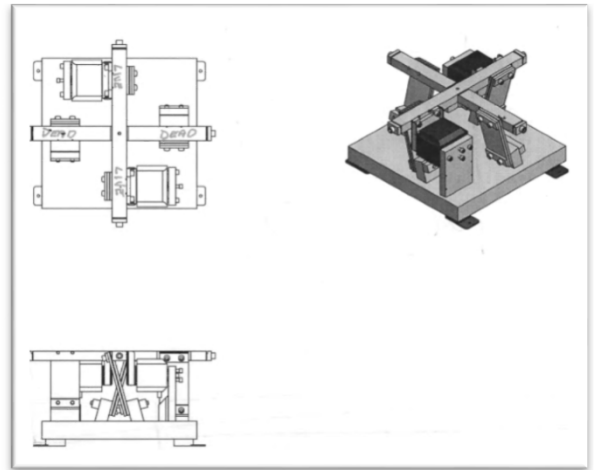

DRIVE UNIT MODEL #

72169

DRIVE UNIT SIZE: 21"

DRIVE UNIT VOLTAGE: 220

DRIVE FREQUENCY: Half Wave

NUMBER OF POSTS: 4

DRIVE ROTATION: CCW

COIL PART NUMBER: 83721

SPRING INFORMATION:

SIZE: 3/16"
PART #: 73730

SPACER INFORMATION:

PART #: 73722

TOE CLAMP PART NUMBER: 73718

MOUNTING FOOT PART NUMBER: 72112

CROSS ARM PART NUMBER: 72161

**RECOMMENDED
QUANTITY**

2 EACH

8 EACH

16 EACH

AS NEEDED

AS NEEDED

ADDITIONAL DRIVE UNIT INFORMATION:

MAY REQUIRE ADDITIONAL SPRINGS FOR TUNING SUCH AS:

1/8"(P/N 73716) AND 1/4"(P/N 73745) AND 3/8"(P/N 73750)

CONTACT MOORFEED FOR PRICING AND AVAILABILITY.

PHONE: (317) 545-7171 FAX: (317) 542-7317 EMAIL: SPARES@MOORFEED.COM

MOORFEED DRIVE UNIT SPARE PARTS LIST

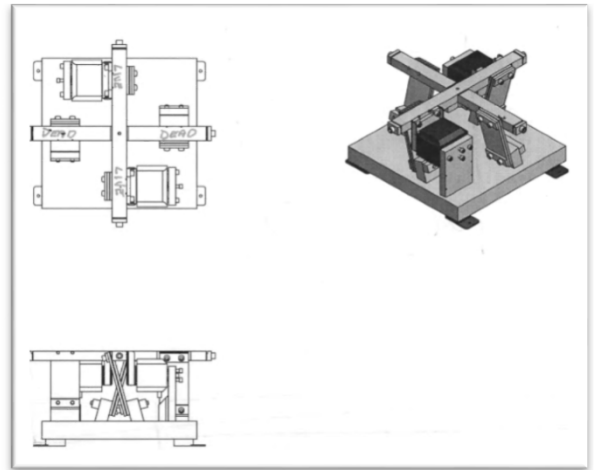

DRIVE UNIT MODEL #

72187

DRIVE UNIT SIZE: 21"

DRIVE UNIT VOLTAGE: 120

DRIVE FREQUENCY: HALF WAVE

NUMBER OF POSTS: 6

DRIVE ROTATION: CW

COIL PART NUMBER: 83821

SPRING INFORMATION:

SIZE: 3/16"
PART #: 73730

SPACER INFORMATION:

PART #: 73722

TOE CLAMP PART NUMBER: 73718

MOUNTING FOOT PART NUMBER: 72112

CROSS ARM PART NUMBER: 72162

**RECOMMENDED
QUANTITY**

2 EACH

8 EACH

16 EACH

AS NEEDED

AS NEEDED

ADDITIONAL DRIVE UNIT INFORMATION:

MAY REQUIRE ADDITIONAL SPRINGS FOR TUNING SUCH AS:

1/8"(P/N 73716) AND 1/4"(P/N 73745) AND 3/8"(P/N 73750)

CONTACT MOORFEED FOR PRICING AND AVAILABILITY.

PHONE: (317) 545-7171 FAX: (317) 542-7317 EMAIL: SPARES@MOORFEED.COM

MOORFEED DRIVE UNIT SPARE PARTS LIST

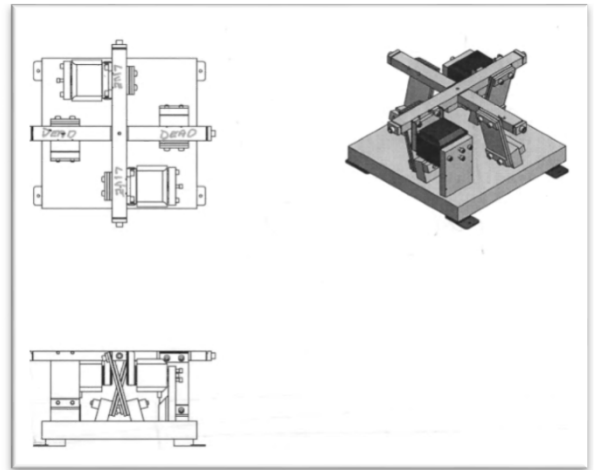

DRIVE UNIT MODEL #

72188

DRIVE UNIT SIZE: 21"

DRIVE UNIT VOLTAGE: 120

DRIVE FREQUENCY: HALF WAVE

NUMBER OF POSTS: 6

DRIVE ROTATION: CCW

COIL PART NUMBER: 83821

SPRING INFORMATION:

SIZE: 3/16"
PART #: 73730

SPACER INFORMATION:

PART #: 73722

TOE CLAMP PART NUMBER: 73718

MOUNTING FOOT PART NUMBER: 72112

CROSS ARM PART NUMBER: 72163

**RECOMMENDED
QUANTITY**

2 EACH

8 EACH

16 EACH

AS NEEDED

AS NEEDED

ADDITIONAL DRIVE UNIT INFORMATION:

MAY REQUIRE ADDITIONAL SPRINGS FOR TUNING SUCH AS:

1/8"(P/N 73716) AND 1/4"(P/N 73745) AND 3/8"(P/N 73750)

CONTACT MOORFEED FOR PRICING AND AVAILABILITY.

PHONE: (317) 545-7171 FAX: (317) 542-7317 EMAIL: SPARES@MOORFEED.COM

MOORFEED DRIVE UNIT SPARE PARTS LIST

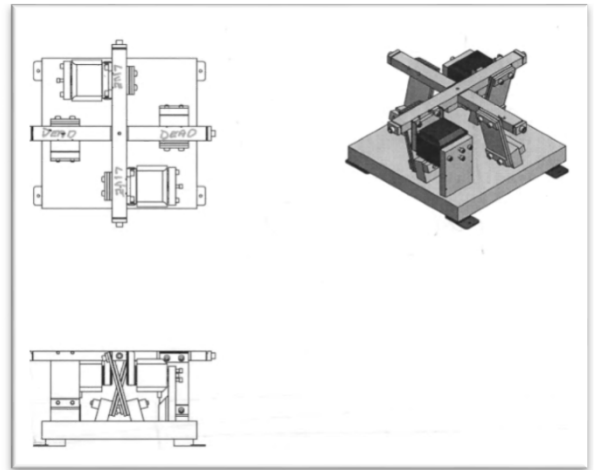

DRIVE UNIT MODEL #

72190

DRIVE UNIT SIZE: 21"

DRIVE UNIT VOLTAGE: 220

DRIVE FREQUENCY: Half Wave

NUMBER OF POSTS: 6

DRIVE ROTATION: CW

COIL PART NUMBER: 83721

SPRING INFORMATION:

SIZE: 3/16"
PART #: 73730

SPACER INFORMATION:

PART #: 73722

TOE CLAMP PART NUMBER: 73718

MOUNTING FOOT PART NUMBER: 72112

CROSS ARM PART NUMBER: 72162

**RECOMMENDED
QUANTITY**

2 EACH

8 EACH

16 EACH

AS NEEDED

AS NEEDED

ADDITIONAL DRIVE UNIT INFORMATION:

MAY REQUIRE ADDITIONAL SPRINGS FOR TUNING SUCH AS:

1/8"(P/N 73716) AND 1/4"(P/N 73745) AND 3/8"(P/N 73750)

CONTACT MOORFEED FOR PRICING AND AVAILABILITY.

PHONE: (317) 545-7171 FAX: (317) 542-7317 EMAIL: SPARES@MOORFEED.COM

MOORFEED DRIVE UNIT SPARE PARTS LIST

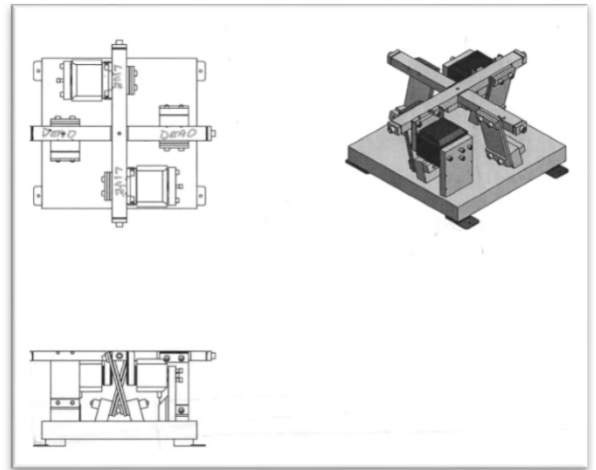

DRIVE UNIT MODEL #

72195

DRIVE UNIT SIZE: 21"

DRIVE UNIT VOLTAGE: 220

DRIVE FREQUENCY: HALF WAVE

NUMBER OF POSTS: 6

DRIVE ROTATION: CCW

COIL PART NUMBER: 83721

SPRING INFORMATION:

SIZE: 3/16"
PART #: 73730

SPACER INFORMATION:

PART #: 73722

TOE CLAMP PART NUMBER: 73718

MOUNTING FOOT PART NUMBER: 72112

CROSS ARM PART NUMBER: 72163

**RECOMMENDED
QUANTITY**

2 EACH

8 EACH

16 EACH

AS NEEDED

AS NEEDED

ADDITIONAL DRIVE UNIT INFORMATION:

MAY REQUIRE ADDITIONAL SPRINGS FOR TUNING SUCH AS:

1/8"(P/N 73716) AND 1/4"(P/N 73745) AND 3/8"(P/N 73750)

CONTACT MOORFEED FOR PRICING AND AVAILABILITY.

PHONE: (317) 545-7171 FAX: (317) 542-7317 EMAIL: SPARES@MOORFEED.COM

MOORFEED DRIVE UNIT SPARE PARTS LIST

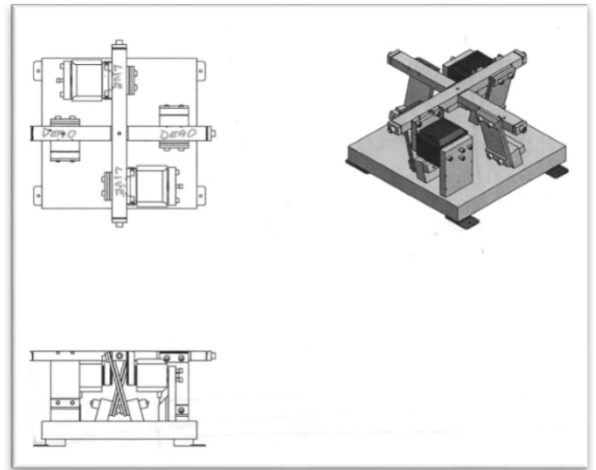

DRIVE UNIT MODEL #

72413

DRIVE UNIT SIZE: 24"

DRIVE UNIT VOLTAGE: 120

DRIVE FREQUENCY: FULL WAVE

NUMBER OF POSTS: 4

DRIVE ROTATION: CW

COIL PART NUMBER: 83821

SPRING INFORMATION:

SIZE: 1/4"
PART #: 73745

SPACER INFORMATION:

PART #: 73722

TOE CLAMP PART NUMBER: 73718

MOUNTING FOOT PART NUMBER: 72212

CROSS ARM PART NUMBER: 72460

**RECOMMENDED
QUANTITY**

2 EACH

8 EACH

16 EACH

AS NEEDED

AS NEEDED

ADDITIONAL DRIVE UNIT INFORMATION:

MAY REQUIRE ADDITIONAL SPRINGS FOR TUNING SUCH AS:

1/8" (P/N 73716), 3/16" (P/N 73730), AND 3/8" (P/N 73750)

CONTACT MOORFEED FOR PRICING AND AVAILABILITY.

PHONE: (317) 545-7171 FAX: (317) 542-7317 EMAIL: SPARES@MOORFEED.COM

MOORFEED DRIVE UNIT SPARE PARTS LIST

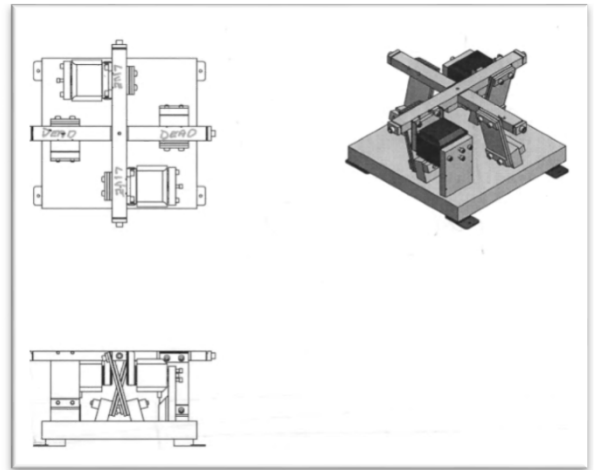

DRIVE UNIT MODEL #

72414

DRIVE UNIT SIZE: 24"

DRIVE UNIT VOLTAGE: 120

DRIVE FREQUENCY: FULL WAVE

NUMBER OF POSTS: 4

DRIVE ROTATION: CCW

COIL PART NUMBER: 83821

SPRING INFORMATION:

SIZE: 1/4"
PART #: 73745

SPACER INFORMATION:

PART #: 73722

TOE CLAMP PART NUMBER: 73718

MOUNTING FOOT PART NUMBER: 72112

CROSS ARM PART NUMBER: 72461

**RECOMMENDED
QUANTITY**

2 EACH

8 EACH

16 EACH

AS NEEDED

AS NEEDED

ADDITIONAL DRIVE UNIT INFORMATION:

MAY REQUIRE ADDITIONAL SPRINGS FOR TUNING SUCH AS:

1/8"(P/N 73716), 3/16"(P/N 73745), AND 3/8"(P/N 73750)

CONTACT MOORFEED FOR PRICING AND AVAILABILITY.

PHONE: (317) 545-7171 FAX: (317) 542-7317 EMAIL: SPARES@MOORFEED.COM

MOORFEED DRIVE UNIT SPARE PARTS LIST

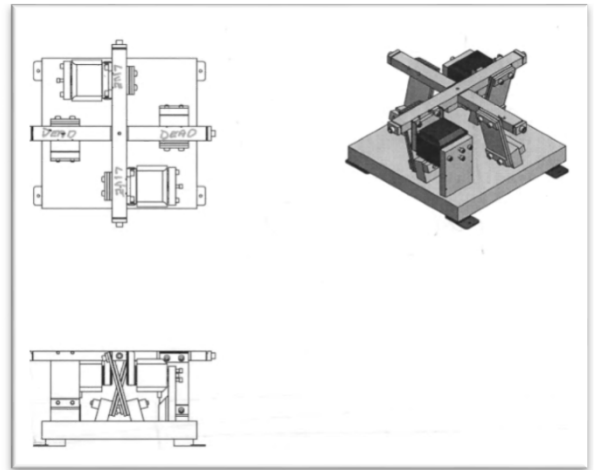

DRIVE UNIT MODEL #

72415

DRIVE UNIT SIZE: 24"

DRIVE UNIT VOLTAGE: 220

DRIVE FREQUENCY: FULL WAVE

NUMBER OF POSTS: 4

DRIVE ROTATION: CW

COIL PART NUMBER: 83721

SPRING INFORMATION:

SIZE: 1/4"
PART #: 73745

SPACER INFORMATION:

PART #: 73722

TOE CLAMP PART NUMBER: 73718

MOUNTING FOOT PART NUMBER: 72112

CROSS ARM PART NUMBER: 72460

**RECOMMENDED
QUANTITY**

2 EACH

8 EACH

16 EACH

AS NEEDED

AS NEEDED

ADDITIONAL DRIVE UNIT INFORMATION:

MAY REQUIRE ADDITIONAL SPRINGS FOR TUNING SUCH AS:

1/8"(P/N 73716), 3/16"(P/N 73730), AND 3/8"(P/N 73750)

CONTACT MOORFEED FOR PRICING AND AVAILABILITY.

PHONE: (317) 545-7171 FAX: (317) 542-7317 EMAIL: SPARES@MOORFEED.COM

MOORFEED DRIVE UNIT SPARE PARTS LIST

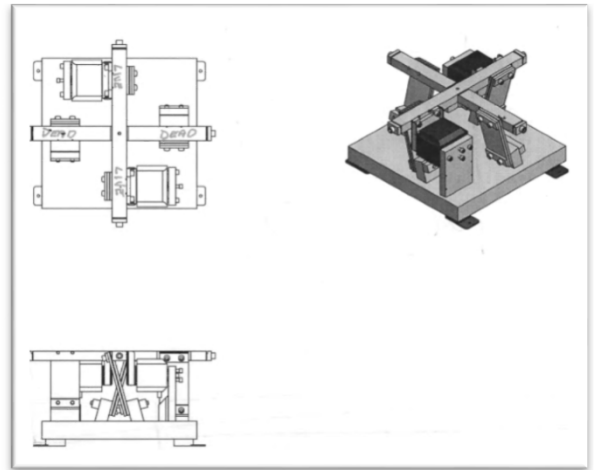

DRIVE UNIT MODEL #

72416

DRIVE UNIT SIZE: 24"

DRIVE UNIT VOLTAGE: 220

DRIVE FREQUENCY: FULL WAVE

NUMBER OF POSTS: 4

DRIVE ROTATION: CCW

COIL PART NUMBER: 83721

SPRING INFORMATION:

SIZE: 1/4"
PART #: 73745

SPACER INFORMATION:

PART #: 73722

TOE CLAMP PART NUMBER: 73718

MOUNTING FOOT PART NUMBER: 72112

CROSS ARM PART NUMBER: 72461

**RECOMMENDED
QUANTITY**

2 EACH

8 EACH

16 EACH

AS NEEDED

AS NEEDED

ADDITIONAL DRIVE UNIT INFORMATION:

MAY REQUIRE ADDITIONAL SPRINGS FOR TUNING SUCH AS:

1/8" (P/N 73716), 3/16" (P/N 73730), AND 3/8" (P/N 73750)

CONTACT MOORFEED FOR PRICING AND AVAILABILITY.

PHONE: (317) 545-7171 FAX: (317) 542-7317 EMAIL: SPARES@MOORFEED.COM

MOORFEED DRIVE UNIT SPARE PARTS LIST

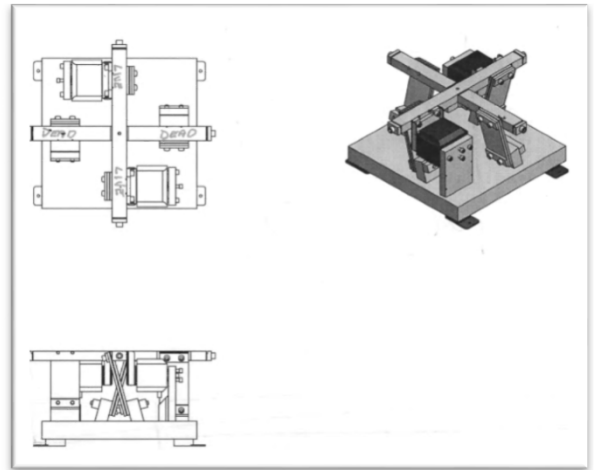

DRIVE UNIT MODEL #

72427

DRIVE UNIT SIZE: 24"

DRIVE UNIT VOLTAGE: 120

DRIVE FREQUENCY: HALF WAVE

NUMBER OF POSTS: 4

DRIVE ROTATION: CW

COIL PART NUMBER: 83821

SPRING INFORMATION:

SIZE: 3/16"
PART #: 73730

SPACER INFORMATION:

PART #: 73722

TOE CLAMP PART NUMBER: 73718

MOUNTING FOOT PART NUMBER: 72112

CROSS ARM PART NUMBER: 72460

**RECOMMENDED
QUANTITY**

2 EACH

8 EACH

16 EACH

AS NEEDED

AS NEEDED

ADDITIONAL DRIVE UNIT INFORMATION:

MAY REQUIRE ADDITIONAL SPRINGS FOR TUNING SUCH AS:

1/8"(P/N 73716), 1/4"(P/N 73745), AND 3/8"(P/N 73750)

CONTACT MOORFEED FOR PRICING AND AVAILABILITY.

PHONE: (317) 545-7171 FAX: (317) 542-7317 EMAIL: SPARES@MOORFEED.COM

MOORFEED DRIVE UNIT SPARE PARTS LIST

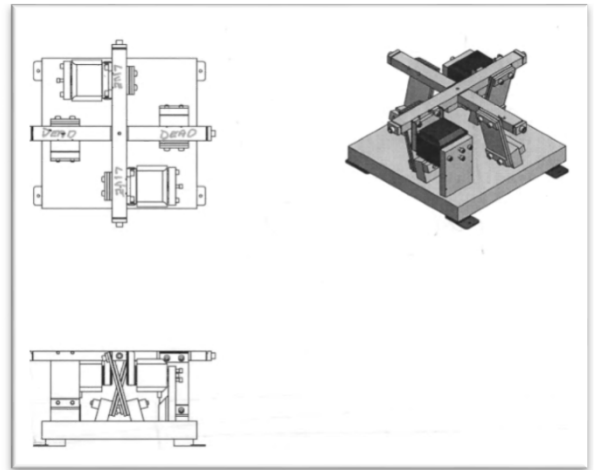

DRIVE UNIT MODEL #

72428

DRIVE UNIT SIZE: 24"

DRIVE UNIT VOLTAGE: 120

DRIVE FREQUENCY: HALF WAVE

NUMBER OF POSTS: 4

DRIVE ROTATION: CCW

COIL PART NUMBER: 83821

SPRING INFORMATION:

SIZE: 3/16"
PART #: 73730

SPACER INFORMATION:

PART #: 73722

TOE CLAMP PART NUMBER: 73718

MOUNTING FOOT PART NUMBER: 72112

CROSS ARM PART NUMBER: 72461

**RECOMMENDED
QUANTITY**

2 EACH

8 EACH

16 EACH

AS NEEDED

AS NEEDED

ADDITIONAL DRIVE UNIT INFORMATION:

MAY REQUIRE ADDITIONAL SPRINGS FOR TUNING SUCH AS:

1/8"(P/N 73716), 1/4"(P/N 73745), AND 3/8"(P/N 73750)

CONTACT MOORFEED FOR PRICING AND AVAILABILITY.

PHONE: (317) 545-7171 FAX: (317) 542-7317 EMAIL: SPARES@MOORFEED.COM

MOORFEED DRIVE UNIT SPARE PARTS LIST

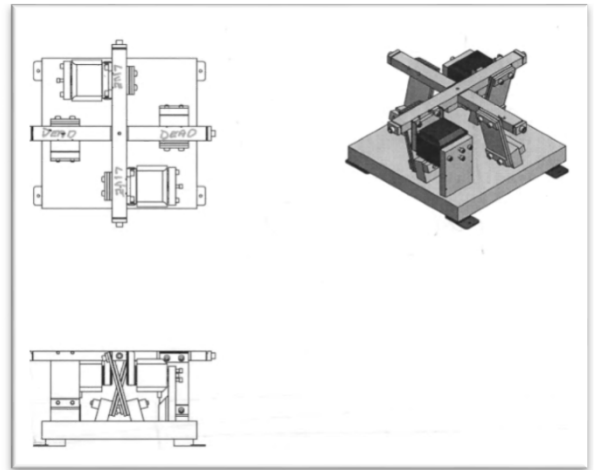

DRIVE UNIT MODEL #

72429

DRIVE UNIT SIZE: 24"

DRIVE UNIT VOLTAGE: 220

DRIVE FREQUENCY: HALF WAVE

NUMBER OF POSTS: 4

DRIVE ROTATION: CW

COIL PART NUMBER: 83721

SPRING INFORMATION:

SIZE: 3/16"
PART #: 73730

SPACER INFORMATION:

PART #: 73722

TOE CLAMP PART NUMBER: 73718

MOUNTING FOOT PART NUMBER: 72112

CROSS ARM PART NUMBER: 72460

**RECOMMENDED
QUANTITY**

2 EACH

8 EACH

16 EACH

AS NEEDED

AS NEEDED

ADDITIONAL DRIVE UNIT INFORMATION:

MAY REQUIRE ADDITIONAL SPRINGS FOR TUNING SUCH AS:

1/8"(P/N 73716), 1/4"(P/N 73745), AND 3/8"(P/N 73750)

CONTACT MOORFEED FOR PRICING AND AVAILABILITY.

PHONE: (317) 545-7171 FAX: (317) 542-7317 EMAIL: SPARES@MOORFEED.COM

MOORFEED DRIVE UNIT SPARE PARTS LIST

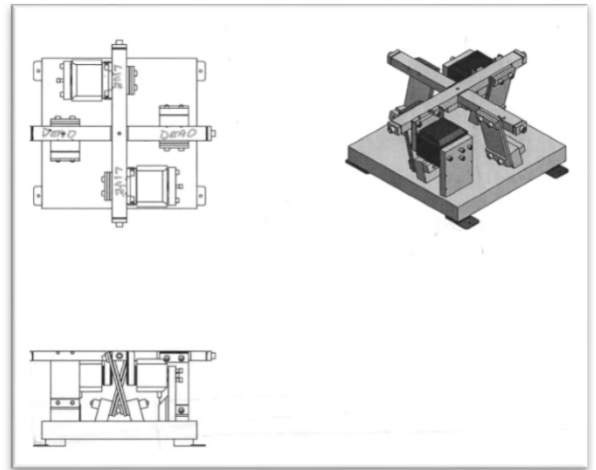

DRIVE UNIT MODEL #

72430

DRIVE UNIT SIZE: 24"

DRIVE UNIT VOLTAGE: 220

DRIVE FREQUENCY: HALF WAVE

NUMBER OF POSTS: 4

DRIVE ROTATION: CCW

COIL PART NUMBER: 83721

SPRING INFORMATION:

SIZE: 3/16"
PART #: 73730

SPACER INFORMATION:

PART #: 73722

TOE CLAMP PART NUMBER: 73718

MOUNTING FOOT PART NUMBER: 72112

CROSS ARM PART NUMBER: 72461

**RECOMMENDED
QUANTITY**

2 EACH

8 EACH

16 EACH

AS NEEDED

AS NEEDED

ADDITIONAL DRIVE UNIT INFORMATION:

MAY REQUIRE ADDITIONAL SPRINGS FOR TUNING SUCH AS:

1/8"(P/N 73716), 1/4"(P/N 73745), AND 3/8"(P/N 73750)

CONTACT MOORFEED FOR PRICING AND AVAILABILITY.

PHONE: (317) 545-7171 FAX: (317) 542-7317 EMAIL: SPARES@MOORFEED.COM

MOORFEED DRIVE UNIT SPARE PARTS LIST

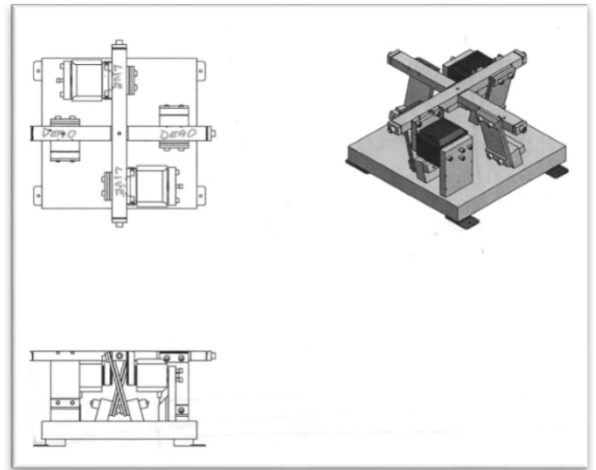

DRIVE UNIT MODEL #

72439

DRIVE UNIT SIZE: 24"

DRIVE UNIT VOLTAGE: 120

DRIVE FREQUENCY: FULL WAVE

NUMBER OF POSTS: 6

DRIVE ROTATION: CW

COIL PART NUMBER: 83821

SPRING INFORMATION:

SIZE: 1/4"
PART #: 73745

SPACER INFORMATION:

PART #: 73722

TOE CLAMP PART NUMBER: 73718

MOUNTING FOOT PART NUMBER: 72112

CROSS ARM PART NUMBER: 72462

**RECOMMENDED
QUANTITY**

2 EACH

8 EACH

16 EACH

AS NEEDED

AS NEEDED

ADDITIONAL DRIVE UNIT INFORMATION:

MAY REQUIRE ADDITIONAL SPRINGS FOR TUNING SUCH AS:

1/8"(P/N 73716), 3/16"(P/N 73730), AND 3/8"(P/N 73750)

CONTACT MOORFEED FOR PRICING AND AVAILABILITY.

PHONE: (317) 545-7171 FAX: (317) 542-7317 EMAIL: SPARES@MOORFEED.COM

MOORFEED DRIVE UNIT SPARE PARTS LIST

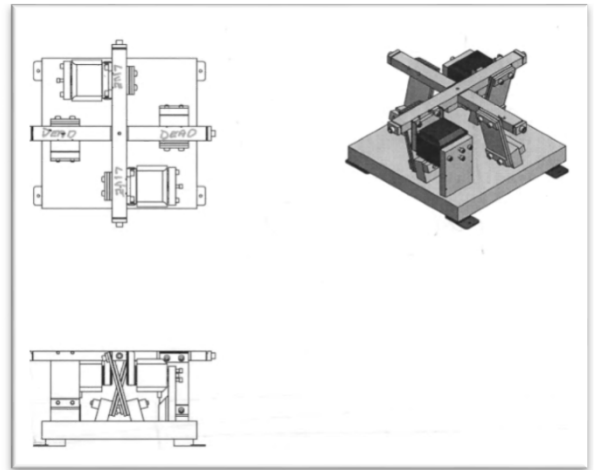

DRIVE UNIT MODEL #

72440

DRIVE UNIT SIZE: 24"

DRIVE UNIT VOLTAGE: 120

DRIVE FREQUENCY: FULL WAVE

NUMBER OF POSTS: 6

DRIVE ROTATION: CCW

COIL PART NUMBER: 83821

SPRING INFORMATION:

SIZE: 1/4"
PART #: 73745

SPACER INFORMATION:

PART #: 73722

TOE CLAMP PART NUMBER: 73718

MOUNTING FOOT PART NUMBER: 72112

CROSS ARM PART NUMBER: 72463

**RECOMMENDED
QUANTITY**

2 EACH

8 EACH

16 EACH

AS NEEDED

AS NEEDED

ADDITIONAL DRIVE UNIT INFORMATION:

MAY REQUIRE ADDITIONAL SPRINGS FOR TUNING SUCH AS:

1/8"(P/N 73716), 3/16"(P/N 73730), 3/8"(P/N 73750)

CONTACT MOORFEED FOR PRICING AND AVAILABILITY.

PHONE: (317) 545-7171 FAX: (317) 542-7317 EMAIL: SPARES@MOORFEED.COM

MOORFEED DRIVE UNIT SPARE PARTS LIST

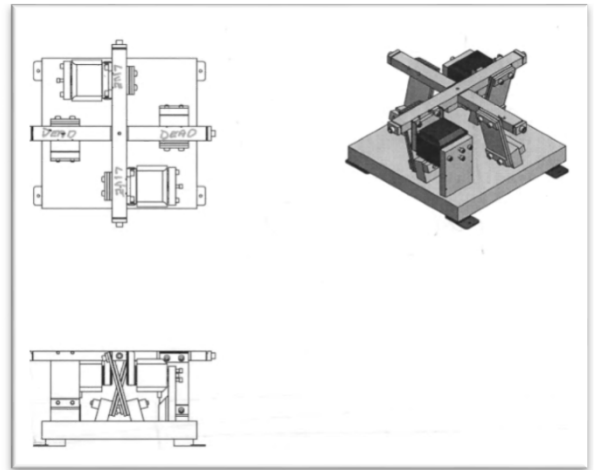

DRIVE UNIT MODEL #

72441

DRIVE UNIT SIZE: 24"

DRIVE UNIT VOLTAGE: 220

DRIVE FREQUENCY: FULL WAVE

NUMBER OF POSTS: 6

DRIVE ROTATION: CW

COIL PART NUMBER: 83721

SPRING INFORMATION:

SIZE: 1/4"
PART #: 73745

SPACER INFORMATION:

PART #: 73722

TOE CLAMP PART NUMBER: 73718

MOUNTING FOOT PART NUMBER: 72112

CROSS ARM PART NUMBER: 72462

**RECOMMENDED
QUANTITY**

2 EACH

8 EACH

16 EACH

AS NEEDED

AS NEEDED

ADDITIONAL DRIVE UNIT INFORMATION:

MAY REQUIRE ADDITIONAL SPRINGS FOR TUNING SUCH AS:

1/8"(P/N 73716), 3/16"(P/N 73730), AND 3/8"(P/N 73750)

CONTACT MOORFEED FOR PRICING AND AVAILABILITY.

PHONE: (317) 545-7171 FAX: (317) 542-7317 EMAIL: SPARES@MOORFEED.COM

MOORFEED DRIVE UNIT SPARE PARTS LIST

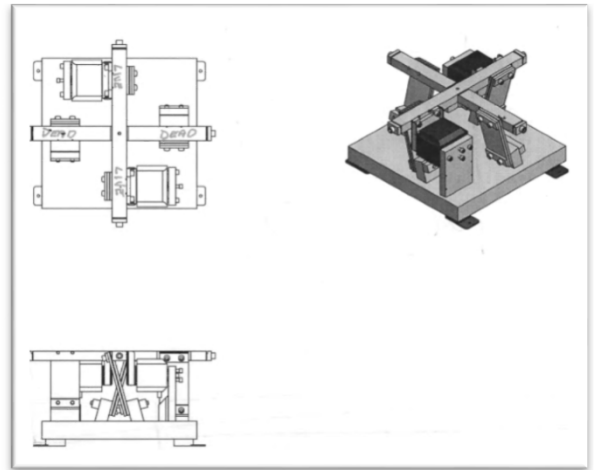

DRIVE UNIT MODEL #

72442

DRIVE UNIT SIZE: 24"

DRIVE UNIT VOLTAGE: 220

DRIVE FREQUENCY: FULL WAVE

NUMBER OF POSTS: 6

DRIVE ROTATION: CCW

COIL PART NUMBER: 83721

SPRING INFORMATION:

SIZE: 1/4"
PART #: 73745

SPACER INFORMATION:

PART #: 73722

TOE CLAMP PART NUMBER: 73718

MOUNTING FOOT PART NUMBER: 72112

CROSS ARM PART NUMBER: 72463

**RECOMMENDED
QUANTITY**

2 EACH

8 EACH

16 EACH

AS NEEDED

AS NEEDED

ADDITIONAL DRIVE UNIT INFORMATION:

MAY REQUIRE ADDITIONAL SPRINGS FOR TUNING SUCH AS:

1/8" (P/N 79716), 3/16" (P/N 73730), AND 3/8" (P/N 73750)

CONTACT MOORFEED FOR PRICING AND AVAILABILITY.

PHONE: (317) 545-7171 FAX: (317) 542-7317 EMAIL: SPARES@MOORFEED.COM

MOORFEED DRIVE UNIT SPARE PARTS LIST

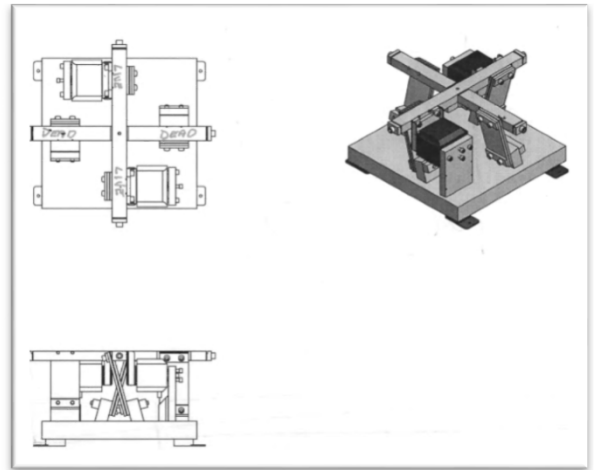

DRIVE UNIT MODEL #

72447

DRIVE UNIT SIZE: 24"

DRIVE UNIT VOLTAGE: 120

DRIVE FREQUENCY: FULL WAVE

NUMBER OF POSTS: 6

DRIVE ROTATION: CCW

COIL PART NUMBER: 83721

SPRING INFORMATION:

SIZE: 1/4"
PART #: 73745

SPACER INFORMATION:

PART #: 73722

TOE CLAMP PART NUMBER: 73718

MOUNTING FOOT PART NUMBER: 72112

CROSS ARM PART NUMBER: 72462

**RECOMMENDED
QUANTITY**

2 EACH

8 EACH

16 EACH

AS NEEDED

AS NEEDED

ADDITIONAL DRIVE UNIT INFORMATION:

MAY REQUIRE ADDITIONAL SPRINGS FOR TUNING SUCH AS:

1/8"(P/N 73716), 3/16"(P/N 73730), AND 3/8"(P/N 73750)

CONTACT MOORFEED FOR PRICING AND AVAILABILITY.

PHONE: (317) 545-7171 FAX: (317) 542-7317 EMAIL: SPARES@MOORFEED.COM

MOORFEED DRIVE UNIT SPARE PARTS LIST

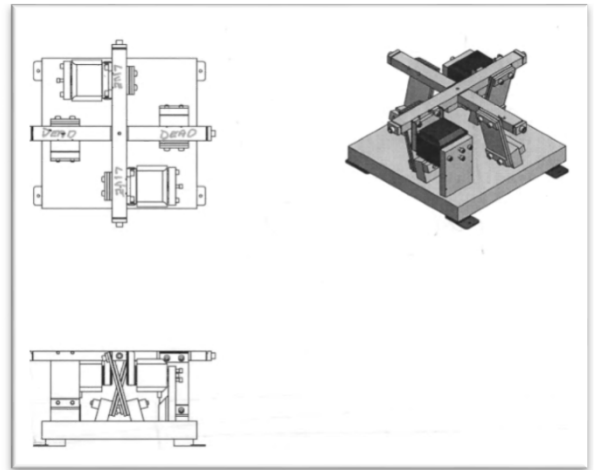

DRIVE UNIT MODEL #

72448

DRIVE UNIT SIZE: 24"

DRIVE UNIT VOLTAGE: 120

DRIVE FREQUENCY: HALF WAVE

NUMBER OF POSTS: 6

DRIVE ROTATION: CCW

COIL PART NUMBER: 83821

SPRING INFORMATION:

SIZE: 3/16"
PART #: 73730

SPACER INFORMATION:

PART #: 73722

TOE CLAMP PART NUMBER: 73718

MOUNTING FOOT PART NUMBER: 72112

CROSS ARM PART NUMBER: 72463

**RECOMMENDED
QUANTITY**

2 EACH

8 EACH

16 EACH

AS NEEDED

AS NEEDED

ADDITIONAL DRIVE UNIT INFORMATION:

MAY REQUIRE ADDITIONAL SPRINGS FOR TUNING SUCH AS:

1/8"(P/N 73716), 1/4"(P/N 73745), AND 3/8"(P/N 73750)

CONTACT MOORFEED FOR PRICING AND AVAILABILITY.

PHONE: (317) 545-7171 FAX: (317) 542-7317 EMAIL: SPARES@MOORFEED.COM

MOORFEED DRIVE UNIT SPARE PARTS LIST

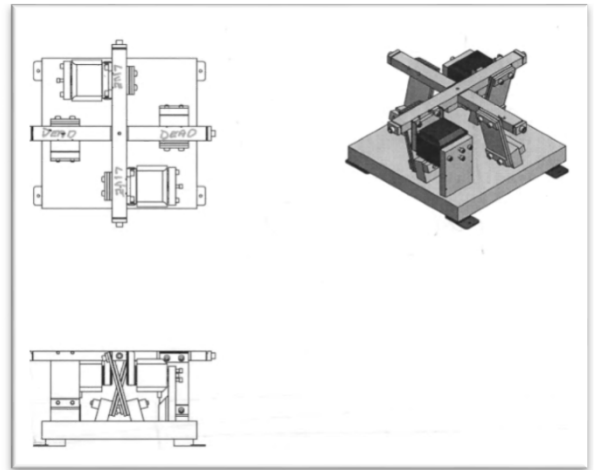

DRIVE UNIT MODEL #

72449

DRIVE UNIT SIZE: 24"

DRIVE UNIT VOLTAGE: 220

DRIVE FREQUENCY: HALF WAVE

NUMBER OF POSTS: 6

DRIVE ROTATION: CW

COIL PART NUMBER: 83721

SPRING INFORMATION:

SIZE: 3/16"
PART #: 73730

SPACER INFORMATION:

PART #: 73722

TOE CLAMP PART NUMBER: 73718

MOUNTING FOOT PART NUMBER: 72112

CROSS ARM PART NUMBER: 72462

**RECOMMENDED
QUANTITY**

2 EACH

8 EACH

16 EACH

AS NEEDED

AS NEEDED

ADDITIONAL DRIVE UNIT INFORMATION:

MAY REQUIRE ADDITIONAL SPRINGS FOR TUNING SUCH AS:

1/8"(P/N 73716), 1/4"(P/N 73730), AND 3/8"(P/N 73750)

CONTACT MOORFEED FOR PRICING AND AVAILABILITY.

PHONE: (317) 545-7171 FAX: (317) 542-7317 EMAIL: SPARES@MOORFEED.COM

MOORFEED DRIVE UNIT SPARE PARTS LIST

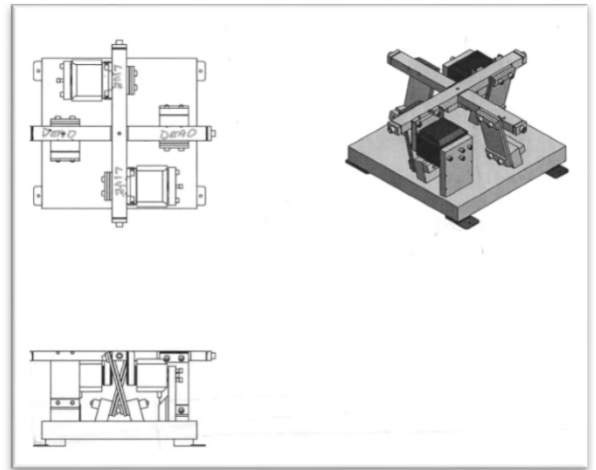

DRIVE UNIT MODEL #

72450

DRIVE UNIT SIZE: 24"

DRIVE UNIT VOLTAGE: 220

DRIVE FREQUENCY: HALF WAVE

NUMBER OF POSTS: 6

DRIVE ROTATION: CCW

COIL PART NUMBER: 83721

SPRING INFORMATION:

SIZE: 3/16"
PART #: 73730

SPACER INFORMATION:

PART #: 73722

TOE CLAMP PART NUMBER: 73718

MOUNTING FOOT PART NUMBER: 72112

CROSS ARM PART NUMBER: 72463

**RECOMMENDED
QUANTITY**

2 EACH

8 EACH

16 EACH

AS NEEDED

AS NEEDED

ADDITIONAL DRIVE UNIT INFORMATION:

MAY REQUIRE ADDITIONAL SPRINGS FOR TUNING SUCH AS:

1/8"(P/N 73716), 1/4"(P/N 73745), AND 3/8"(P/N 73750)

CONTACT MOORFEED FOR PRICING AND AVAILABILITY.

PHONE: (317) 545-7171 FAX: (317) 542-7317 EMAIL: SPARES@MOORFEED.COM

MOORFEED DRIVE UNIT SPARE PARTS LIST

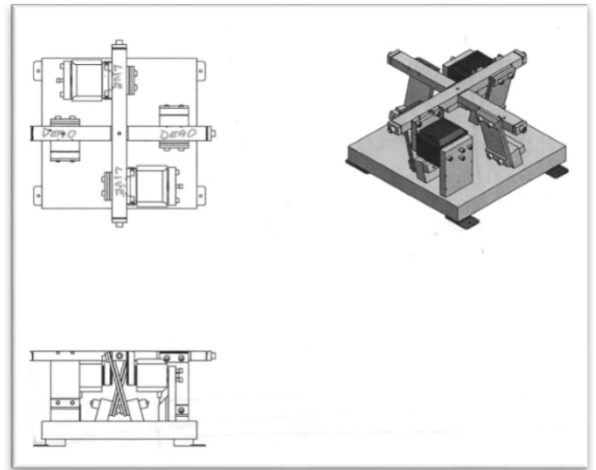

DRIVE UNIT MODEL #

72735

DRIVE UNIT SIZE: 27"

DRIVE UNIT VOLTAGE: 120

DRIVE FREQUENCY: HALF WAVE

NUMBER OF POSTS: 6

DRIVE ROTATION: CW

COIL PART NUMBER: 83821

SPRING INFORMATION:

SIZE: 3/16"
PART #: 73730

SPACER INFORMATION:

PART #: 73722

TOE CLAMP PART NUMBER: 72759

MOUNTING FOOT PART NUMBER: 89261

CROSS ARM PART NUMBER: 72762

**RECOMMENDED
QUANTITY**

2 EACH

8 EACH

16 EACH

AS NEEDED

AS NEEDED

ADDITIONAL DRIVE UNIT INFORMATION:

MAY REQUIRE ADDITIONAL SPRINGS FOR TUNING SUCH AS:

1/8"(P/N 73716), 1/4"(P/N 73745), AND 3/8"(P/N 73750)

CONTACT MOORFEED FOR PRICING AND AVAILABILITY.

PHONE: (317) 545-7171 FAX: (317) 542-7317 EMAIL: SPARES@MOORFEED.COM

MOORFEED DRIVE UNIT SPARE PARTS LIST

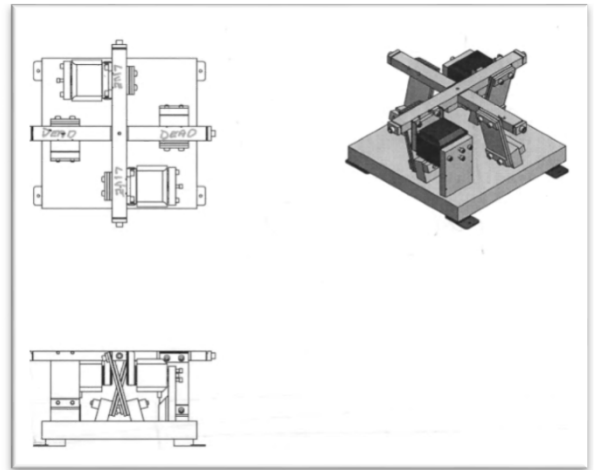

DRIVE UNIT MODEL #

72736

DRIVE UNIT SIZE: 27"

DRIVE UNIT VOLTAGE: 120

DRIVE FREQUENCY: HALF WAVE

NUMBER OF POSTS: 6

DRIVE ROTATION: CCW

COIL PART NUMBER: 83821

SPRING INFORMATION:

SIZE: 3/16"
PART #: 73730

SPACER INFORMATION:

PART #: 73722

TOE CLAMP PART NUMBER: 72759

MOUNTING FOOT PART NUMBER: 89261

CROSS ARM PART NUMBER: 72763

**RECOMMENDED
QUANTITY**

2 EACH

8 EACH

16 EACH

AS NEEDED

AS NEEDED

ADDITIONAL DRIVE UNIT INFORMATION:

MAY REQUIRE ADDITIONAL SPRINGS FOR TUNING SUCH AS:

1/8"(P/N 73716), 1/4"(P/N73745), AND 3/8"(P/N 73750)

CONTACT MOORFEED FOR PRICING AND AVAILABILITY.

PHONE: (317) 545-7171 FAX: (317) 542-7317 EMAIL: SPARES@MOORFEED.COM

MOORFEED DRIVE UNIT SPARE PARTS LIST

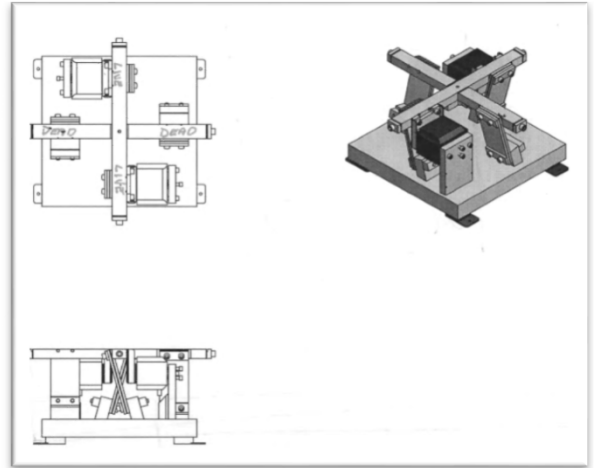

DRIVE UNIT MODEL #

72737

DRIVE UNIT SIZE: 27"

DRIVE UNIT VOLTAGE: 220

DRIVE FREQUENCY: HALF WAVE

NUMBER OF POSTS: 6

DRIVE ROTATION: CW

COIL PART NUMBER: 83721

SPRING INFORMATION:

SIZE: 3/16"
PART #: 73730

SPACER INFORMATION:

PART #: 73722

TOE CLAMP PART NUMBER: 72759

MOUNTING FOOT PART NUMBER: 89261

CROSS ARM PART NUMBER: 72762

**RECOMMENDED
QUANTITY**

2 EACH

8 EACH

16 EACH

AS NEEDED

AS NEEDED

ADDITIONAL DRIVE UNIT INFORMATION:

MAY REQUIRE ADDITIONAL SPRINGS FOR TUNING SUCH AS:

1/8"(P/N 73716), 1/4"(P/N 73745), AND 3/8"(P/N 73750)

CONTACT MOORFEED FOR PRICING AND AVAILABILITY.

PHONE: (317) 545-7171 FAX: (317) 542-7317 EMAIL: SPARES@MOORFEED.COM

MOORFEED DRIVE UNIT SPARE PARTS LIST

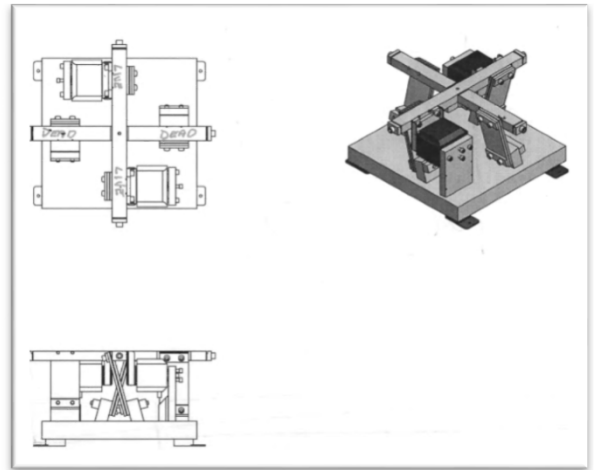

DRIVE UNIT MODEL #

72738

DRIVE UNIT SIZE: 27'

DRIVE UNIT VOLTAGE: 220

DRIVE FREQUENCY: HALF WAVE

NUMBER OF POSTS: 6

DRIVE ROTATION: CCW

COIL PART NUMBER: 83721

**RECOMMENDED
QUANTITY**

2 EACH

SPRING INFORMATION:

SIZE: 3/16"
PART #: 73730

8 EACH

SPACER INFORMATION:

PART #: 73722

16 EACH

TOE CLAMP PART NUMBER: 72759

AS NEEDED

MOUNTING FOOT PART NUMBER: 89261

AS NEEDED

CROSS ARM PART NUMBER: 72763

ADDITIONAL DRIVE UNIT INFORMATION:

MAY REQUIRE ADDITIONAL SPRINGS FOR TUNING SUCH AS:

1/8"(P/N 73716), 1/4"(P/N 73745), AND 3/8"(P/N 73750)

CONTACT MOORFEED FOR PRICING AND AVAILABILITY.

PHONE: (317) 545-7171 FAX: (317) 542-7317 EMAIL: SPARES@MOORFEED.COM

MOORFEED DRIVE UNIT SPARE PARTS LIST

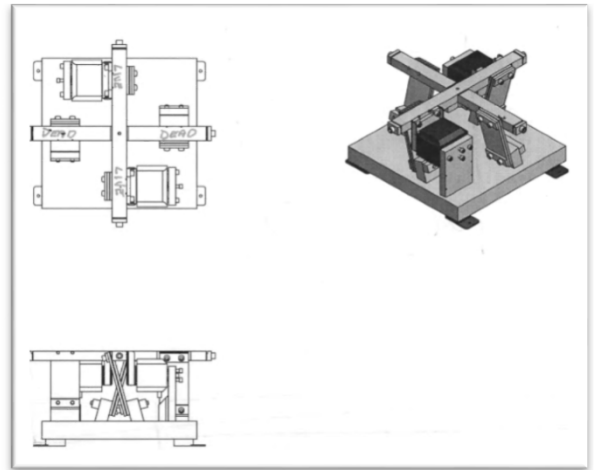

DRIVE UNIT MODEL #

73035

DRIVE UNIT SIZE: 30"

DRIVE UNIT VOLTAGE: 120

DRIVE FREQUENCY: HALF WAVE

NUMBER OF POSTS: 6

DRIVE ROTATION: CW

COIL PART NUMBER: 83821

SPRING INFORMATION:

SIZE: 3/16"
PART #: 73730

SPACER INFORMATION:

PART #: 73722

TOE CLAMP PART NUMBER: 73718

MOUNTING FOOT PART NUMBER: 89261

CROSS ARM PART NUMBER: 73062

**RECOMMENDED
QUANTITY**

2 EACH

8 EACH

16 EACH

AS NEEDED

AS NEEDED

ADDITIONAL DRIVE UNIT INFORMATION:

MAY REQUIRE ADDITIONAL SPRINGS FOR TUNING SUCH AS:

1/8"(P/N 73716), 1/4"(P/N 73745), AND 3/8"(P/N 73750)

CONTACT MOORFEED FOR PRICING AND AVAILABILITY.

PHONE: (317) 545-7171 FAX: (317) 542-7317 EMAIL: SPARES@MOORFEED.COM

MOORFEED DRIVE UNIT SPARE PARTS LIST

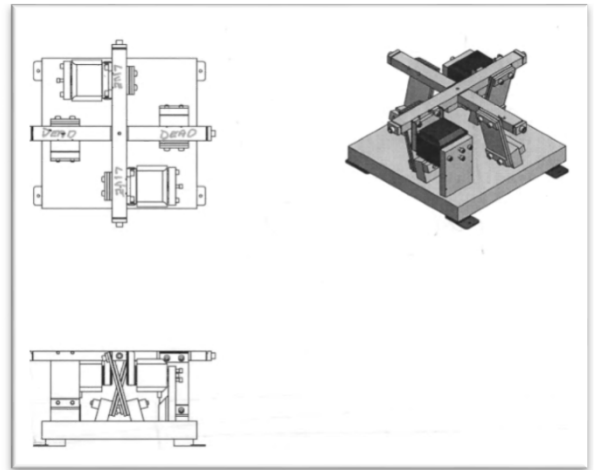

DRIVE UNIT MODEL #

73036

DRIVE UNIT SIZE: 30"

DRIVE UNIT VOLTAGE: 120

DRIVE FREQUENCY: HALF WAVE

NUMBER OF POSTS: 6

DRIVE ROTATION: CCW

COIL PART NUMBER: 83821

SPRING INFORMATION:

SIZE: 3/16"
PART #: 73730

SPACER INFORMATION:

PART #: 73722

TOE CLAMP PART NUMBER: 73718

MOUNTING FOOT PART NUMBER: 89261

CROSS ARM PART NUMBER: 73063

**RECOMMENDED
QUANTITY**

2 EACH

8 EACH

16 EACH

AS NEEDED

AS NEEDED

ADDITIONAL DRIVE UNIT INFORMATION:

MAY REQUIRE ADDITIONAL SPRINGS FOR TUNING SUCH AS:

1/8"(P/N 73716), 1/4"(P/N 73745), AND 3/8"(73750)

CONTACT MOORFEED FOR PRICING AND AVAILABILITY.

PHONE: (317) 545-7171 FAX: (317) 542-7317 EMAIL: SPARES@MOORFEED.COM

MOORFEED DRIVE UNIT SPARE PARTS LIST

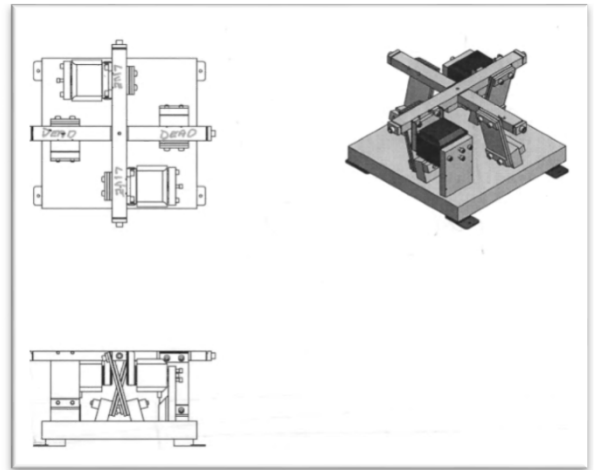

DRIVE UNIT MODEL #

73037

DRIVE UNIT SIZE: 30"

DRIVE UNIT VOLTAGE: 220

DRIVE FREQUENCY: HALF WAVE

NUMBER OF POSTS: 6

DRIVE ROTATION: CW

COIL PART NUMBER: 83721

SPRING INFORMATION:

SIZE: 3/16"
PART #: 73730

SPACER INFORMATION:

PART #: 73722

TOE CLAMP PART NUMBER: 73718

MOUNTING FOOT PART NUMBER: 89261

CROSS ARM PART NUMBER: 73062

**RECOMMENDED
QUANTITY**

2 EACH

8 EACH

16 EACH

AS NEEDED

AS NEEDED

ADDITIONAL DRIVE UNIT INFORMATION:

MAY REQUIRE ADDITIONAL SPRINGS FOR TUNING SUCH AS:

1/8"(P/N 73716), 1/4"(P/N 73745), AND 3/8"(P/N 73750)

CONTACT MOORFEED FOR PRICING AND AVAILABILITY.

PHONE: (317) 545-7171 FAX: (317) 542-7317 EMAIL: SPARES@MOORFEED.COM

MOORFEED DRIVE UNIT SPARE PARTS LIST

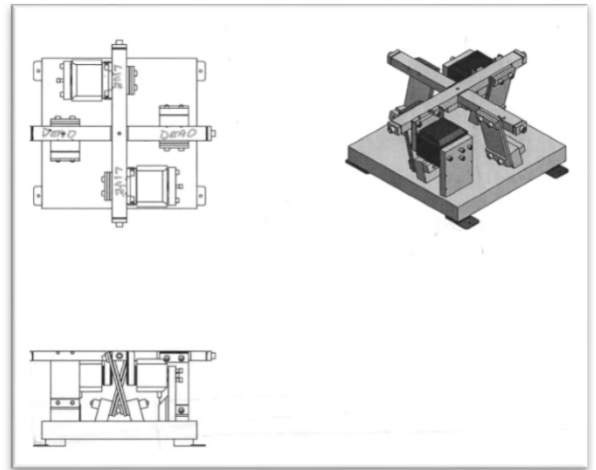

DRIVE UNIT MODEL #

73038

DRIVE UNIT SIZE: 30"

DRIVE UNIT VOLTAGE: 220

DRIVE FREQUENCY: HALF WAVE

NUMBER OF POSTS: 6

DRIVE ROTATION: CCW

COIL PART NUMBER: 83721

SPRING INFORMATION:

SIZE: 3/16"
PART #: 73730

SPACER INFORMATION:

PART #: 73722

TOE CLAMP PART NUMBER: 73718

MOUNTING FOOT PART NUMBER: 89261

CROSS ARM PART NUMBER: 73063

**RECOMMENDED
QUANTITY**

2 EACH

8 EACH

16 EACH

AS NEEDED

AS NEEDED

ADDITIONAL DRIVE UNIT INFORMATION:

MAY REQUIRE ADDITIONAL SPRINGS FOR TUNING SUCH AS:

1/8"(P/N 73716), 1/4"(P/N 73745), AND 3/8"(P/N 73750)

CONTACT MOORFEED FOR PRICING AND AVAILABILITY.

PHONE: (317) 545-7171 FAX: (317) 542-7317 EMAIL: SPARES@MOORFEED.COM

MOORFEED DRIVE UNIT SPARE PARTS LIST

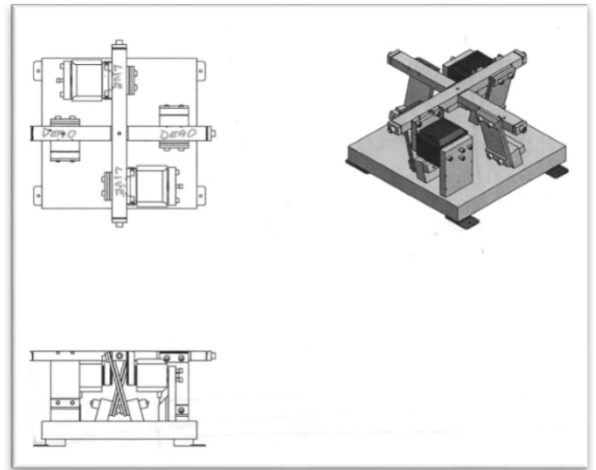

DRIVE UNIT MODEL #

73043

DRIVE UNIT SIZE: 30"

DRIVE UNIT VOLTAGE: 120

DRIVE FREQUENCY: HALF WAVE

NUMBER OF POSTS: 8

DRIVE ROTATION: CW

COIL PART NUMBER: 83821

SPRING INFORMATION:

SIZE: 3/16"
PART #: 73730

SPACER INFORMATION:

PART #: 73722

TOE CLAMP PART NUMBER: 73718

MOUNTING FOOT PART NUMBER: 89261

CROSS ARM PART NUMBER: 73066

**RECOMMENDED
QUANTITY**

2 EACH

8 EACH

16 EACH

AS NEEDED

AS NEEDED

ADDITIONAL DRIVE UNIT INFORMATION:

MAY REQUIRE ADDITIONAL SPRINGS FOR TUNING SUCH AS:

1/8"(P/N 73716), 1/4"(P/N 73745), AND 3/8"(P/N 73750)

CONTACT MOORFEED FOR PRICING AND AVAILABILITY.

PHONE: (317) 545-7171 FAX: (317) 542-7317 EMAIL: SPARES@MOORFEED.COM

MOORFEED DRIVE UNIT SPARE PARTS LIST

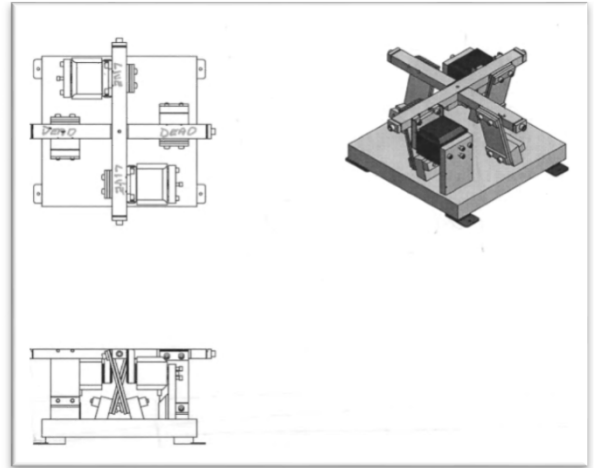

DRIVE UNIT MODEL #

73044

DRIVE UNIT SIZE: 30"

DRIVE UNIT VOLTAGE: 120

DRIVE FREQUENCY: HALF WAVE

NUMBER OF POSTS: 8

DRIVE ROTATION: CCW

COIL PART NUMBER: 83821

SPRING INFORMATION:

SIZE: 3/16"
PART #: 73730

SPACER INFORMATION:

PART #: 73722

TOE CLAMP PART NUMBER: 73718

MOUNTING FOOT PART NUMBER: 89261

CROSS ARM PART NUMBER: 73067

**RECOMMENDED
QUANTITY**

2 EACH

8 EACH

16 EACH

AS NEEDED

AS NEEDED

ADDITIONAL DRIVE UNIT INFORMATION:

MAY REQUIRE ADDITIONAL SPRINGS FOR TUNING SUCH AS:

1/8"(P/N 73716), 1/4"(P/N 73745), AND 3/8"(P/N 73750)

CONTACT MOORFEED FOR PRICING AND AVAILABILITY.

PHONE: (317) 545-7171 FAX: (317) 542-7317 EMAIL: SPARES@MOORFEED.COM

MOORFEED DRIVE UNIT SPARE PARTS LIST

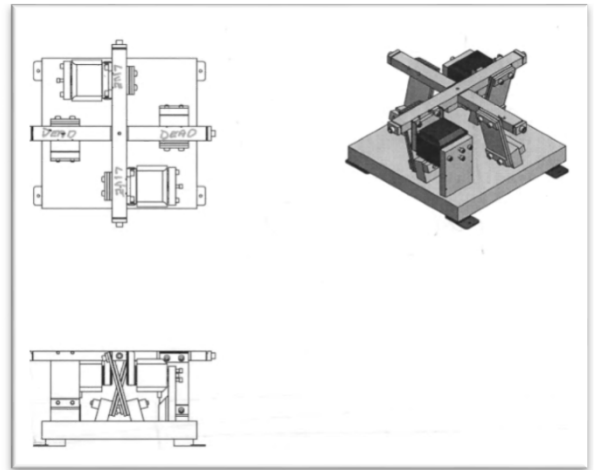

DRIVE UNIT MODEL #

73045

DRIVE UNIT SIZE: 30"

DRIVE UNIT VOLTAGE: 220

DRIVE FREQUENCY: HALF WAVE

NUMBER OF POSTS: 8

DRIVE ROTATION: CW

COIL PART NUMBER: 83721

SPRING INFORMATION:

SIZE: 3/16"
PART #: 73730

SPACER INFORMATION:

PART #: 73722

TOE CLAMP PART NUMBER: 73718

MOUNTING FOOT PART NUMBER: 89261

CROSS ARM PART NUMBER: 73066

**RECOMMENDED
QUANTITY**

2 EACH

8 EACH

16 EACH

AS NEEDED

AS NEEDED

ADDITIONAL DRIVE UNIT INFORMATION:

MAY REQUIRE ADDITIONAL SPRINGS FOR TUNING SUCH AS:

1/8"(P/N 73716), 1/4"(P/N 73745), AND 3/8"(73750)

CONTACT MOORFEED FOR PRICING AND AVAILABILITY.

PHONE: (317) 545-7171 FAX: (317) 542-7317 EMAIL: SPARES@MOORFEED.COM

MOORFEED DRIVE UNIT SPARE PARTS LIST

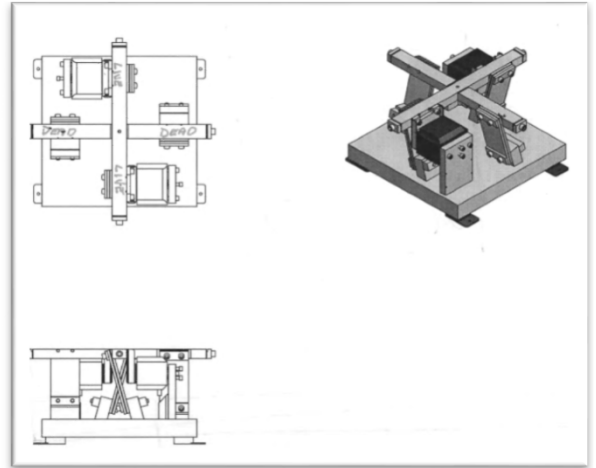

DRIVE UNIT MODEL #

73046

DRIVE UNIT SIZE: 30"

DRIVE UNIT VOLTAGE: 220

DRIVE FREQUENCY: HALF WAVE

NUMBER OF POSTS: 8

DRIVE ROTATION: CCW

COIL PART NUMBER: 83721

**RECOMMENDED
QUANTITY**

2 EACH

SPRING INFORMATION:

SIZE: 3/16"
PART #: 73730

8 EACH

SPACER INFORMATION:

PART #: 73722

16 EACH

TOE CLAMP PART NUMBER: 73718

AS NEEDED

MOUNTING FOOT PART NUMBER: 89261

AS NEEDED

CROSS ARM PART NUMBER: 73067

ADDITIONAL DRIVE UNIT INFORMATION:

CONTACT MOORFEED FOR PRICING AND AVAILABILITY.

PHONE: (317) 545-7171 FAX: (317) 542-7317 EMAIL: SPARES@MOORFEED.COM

MOORFEED DRIVE UNIT SPARE PARTS LIST

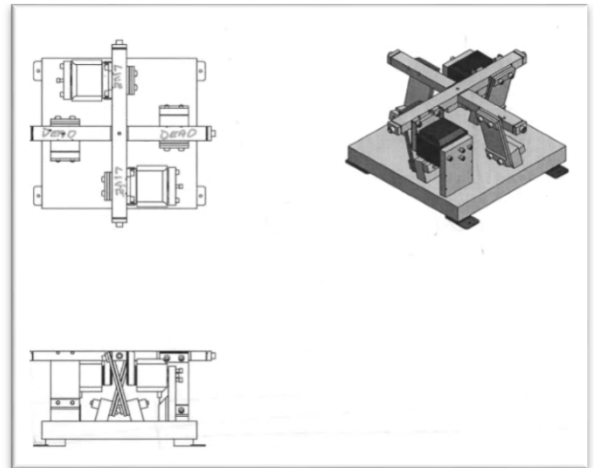

DRIVE UNIT MODEL #

73635

DRIVE UNIT SIZE: 36"

DRIVE UNIT VOLTAGE: 120

DRIVE FREQUENCY: HALF WAVE

NUMBER OF POSTS: 6

DRIVE ROTATION: CW

COIL PART NUMBER: 83821

SPRING INFORMATION:

SIZE: 3/16"
PART #: 73730

SPACER INFORMATION:

PART #: 73722

TOE CLAMP PART NUMBER: 73618

MOUNTING FOOT PART NUMBER: 89261

CROSS ARM PART NUMBER: 73662

**RECOMMENDED
QUANTITY**

2 EACH

8 EACH

16 EACH

AS NEEDED

AS NEEDED

ADDITIONAL DRIVE UNIT INFORMATION:

MAY REQUIRE ADDITIONAL SPRINGS FOR TUNING SUCH AS:

1/8"(P/N 73716), 1/4"(P/N 73745), AND 3/8"(P/N 73750)

CONTACT MOORFEED FOR PRICING AND AVAILABILITY.

PHONE: (317) 545-7171 FAX: (317) 542-7317 EMAIL: SPARES@MOORFEED.COM

MOORFEED DRIVE UNIT SPARE PARTS LIST

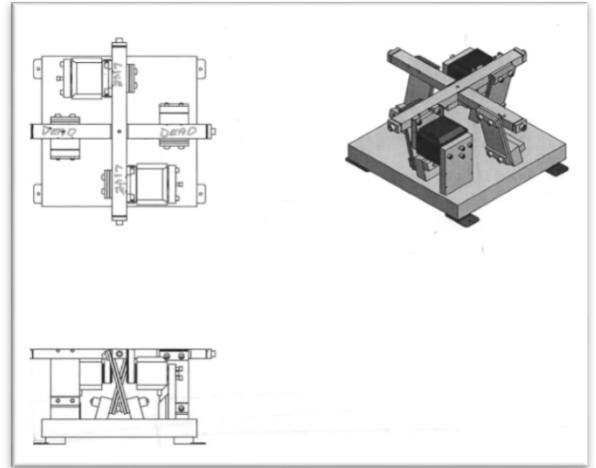

DRIVE UNIT MODEL #

73636

DRIVE UNIT SIZE: 36"

DRIVE UNIT VOLTAGE: 120

DRIVE FREQUENCY: HALF WAVE

NUMBER OF POSTS: 6

DRIVE ROTATION: CCW

COIL PART NUMBER: 83821

SPRING INFORMATION:

SIZE: 3/16"
PART #: 73730

SPACER INFORMATION:

PART #: 73722

TOE CLAMP PART NUMBER: 73618

MOUNTING FOOT PART NUMBER: 89261

CROSS ARM PART NUMBER: 73663

**RECOMMENDED
QUANTITY**

2 EACH

8 EACH

16 EACH

AS NEEDED

AS NEEDED

ADDITIONAL DRIVE UNIT INFORMATION:

MAY REQUIRE ADDITIONAL SPRINGS FOR TUNING SUCH AS:

1/8"(P/N 73716), 1/4"(P/N 73745), AND 3/8"(P/N 73750)

CONTACT MOORFEED FOR PRICING AND AVAILABILITY.

PHONE: (317) 545-7171 FAX: (317) 542-7317 EMAIL: SPARES@MOORFEED.COM

MOORFEED DRIVE UNIT SPARE PARTS LIST

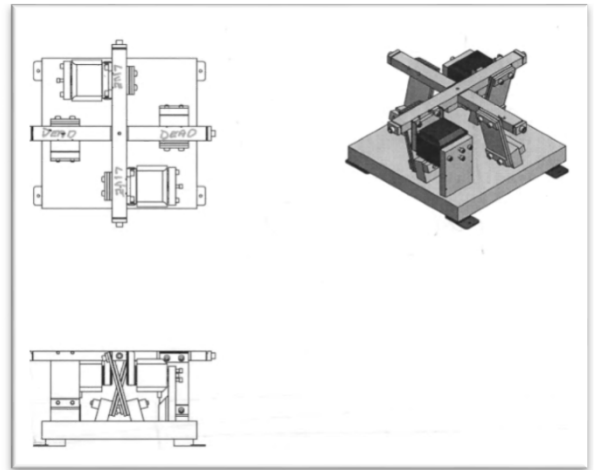

DRIVE UNIT MODEL #

73637

DRIVE UNIT SIZE: 36"

DRIVE UNIT VOLTAGE: 220

DRIVE FREQUENCY: HALF WAVE

NUMBER OF POSTS: 6

DRIVE ROTATION: CW

COIL PART NUMBER: 83721

SPRING INFORMATION:

SIZE: 3/16"
PART #: 73730

SPACER INFORMATION:

PART #: 73722

TOE CLAMP PART NUMBER: 73618

MOUNTING FOOT PART NUMBER: 89261

CROSS ARM PART NUMBER: 73662

**RECOMMENDED
QUANTITY**

2 EACH

8 EACH

16 EACH

AS NEEDED

AS NEEDED

ADDITIONAL DRIVE UNIT INFORMATION:

MAY REQUIRE ADDITIONAL SPRINGS FOR TUNING SUCH AS:

1/8"(P/N 73716), 1/4"(P/N 73745), AND 3/8"(P/N 73750)

CONTACT MOORFEED FOR PRICING AND AVAILABILITY.

PHONE: (317) 545-7171 FAX: (317) 542-7317 EMAIL: SPARES@MOORFEED.COM

MOORFEED DRIVE UNIT SPARE PARTS LIST

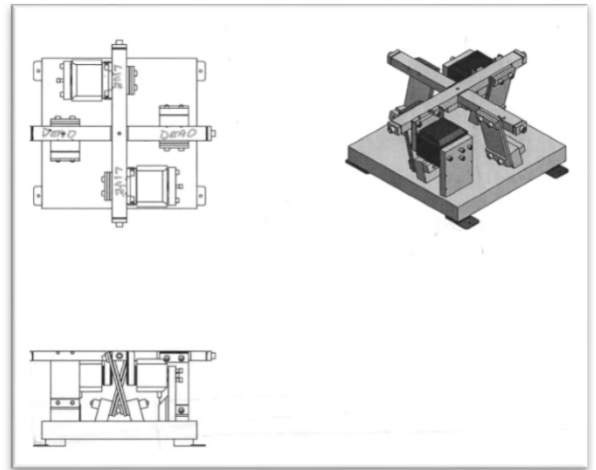

DRIVE UNIT MODEL #

73638

DRIVE UNIT SIZE: 36"

DRIVE UNIT VOLTAGE: 220

DRIVE FREQUENCY: Half Wave

NUMBER OF POSTS: 6

DRIVE ROTATION: CCW

COIL PART NUMBER: 83721

SPRING INFORMATION:

SIZE: 3/16"
PART #: 73730

SPACER INFORMATION:

PART #: 73722

TOE CLAMP PART NUMBER: 73618

MOUNTING FOOT PART NUMBER: 89261

CROSS ARM PART NUMBER: 73663

**RECOMMENDED
QUANTITY**

2 EACH

8 EACH

16 EACH

AS NEEDED

AS NEEDED

ADDITIONAL DRIVE UNIT INFORMATION:

MAY REQUIRE ADDITIONAL SPRINGS FOR TUNING SUCH AS:

1/8"(P/N 73716), 1/4"(P/N 73745), AND 3/8"(P/N 73750)

CONTACT MOORFEED FOR PRICING AND AVAILABILITY.

PHONE: (317) 545-7171 FAX: (317) 542-7317 EMAIL: SPARES@MOORFEED.COM

MOORFEED DRIVE UNIT SPARE PARTS LIST

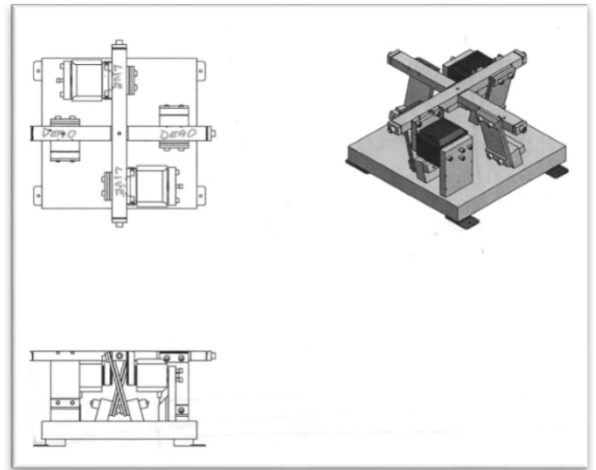

DRIVE UNIT MODEL #

73643

DRIVE UNIT SIZE: 36"

DRIVE UNIT VOLTAGE: 220

DRIVE FREQUENCY: HALF WAVE

NUMBER OF POSTS: 8

DRIVE ROTATION: CW

COIL PART NUMBER: 83721

SPRING INFORMATION:

SIZE: 3/16"
PART #: 73730

SPACER INFORMATION:

PART #: 73722

TOE CLAMP PART NUMBER: 73618

MOUNTING FOOT PART NUMBER: 89261

CROSS ARM PART NUMBER: 73664

**RECOMMENDED
QUANTITY**

2 EACH

8 EACH

16 EACH

AS NEEDED

AS NEEDED

ADDITIONAL DRIVE UNIT INFORMATION:

MAY REQUIRE ADDITIONAL SPRINGS FOR TUNING SUCH AS:

1/8"(P/N 73716), 1/4"(P/N 73745), AND 3/8"(P/N 73750)

CONTACT MOORFEED FOR PRICING AND AVAILABILITY.

PHONE: (317) 545-7171 FAX: (317) 542-7317 EMAIL: SPARES@MOORFEED.COM

MOORFEED DRIVE UNIT SPARE PARTS LIST

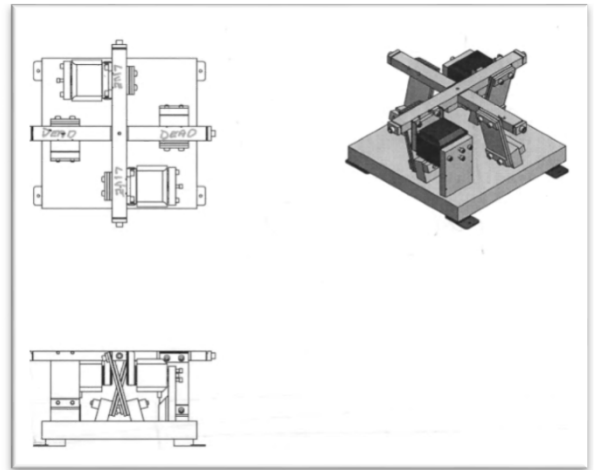

DRIVE UNIT MODEL #

73644

DRIVE UNIT SIZE: 36"

DRIVE UNIT VOLTAGE: 220

DRIVE FREQUENCY: HALF WAVE

NUMBER OF POSTS: 8

DRIVE ROTATION: CCW

COIL PART NUMBER: 83721

SPRING INFORMATION:

SIZE: 3/16"
PART #: 73730

SPACER INFORMATION:

PART #: 73722

TOE CLAMP PART NUMBER: 73618

MOUNTING FOOT PART NUMBER: 89261

CROSS ARM PART NUMBER: 73665

**RECOMMENDED
QUANTITY**

2 EACH

8 EACH

16 EACH

AS NEEDED

AS NEEDED

ADDITIONAL DRIVE UNIT INFORMATION:

MAY REQUIRE ADDITIONAL SPRINGS FOR TUNING SUCH AS:

1/8"(P/N 73716), 1/4"(P/N 73745), AND 3/8"(P/N 73750)

CONTACT MOORFEED FOR PRICING AND AVAILABILITY.

PHONE: (317) 545-7171 FAX: (317) 542-7317 EMAIL: SPARES@MOORFEED.COM

MOORFEED DRIVE UNIT SPARE PARTS LIST

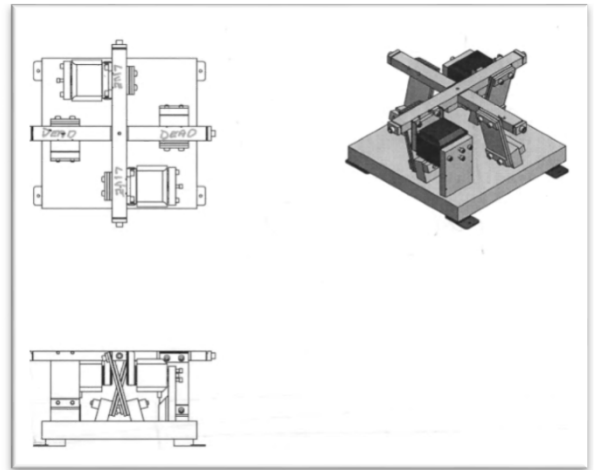

DRIVE UNIT MODEL #

73697

DRIVE UNIT SIZE: 36"

DRIVE UNIT VOLTAGE: 120

DRIVE FREQUENCY: HALF WAVE

NUMBER OF POSTS: 8

DRIVE ROTATION: CW

COIL PART NUMBER: 83821

SPRING INFORMATION:

SIZE: 3/16"
PART #: 73730

SPACER INFORMATION:

PART #: 73722

TOE CLAMP PART NUMBER: 73618

MOUNTING FOOT PART NUMBER: 89261

CROSS ARM PART NUMBER: 73664

**RECOMMENDED
QUANTITY**

2 EACH

8 EACH

16 EACH

AS NEEDED

AS NEEDED

ADDITIONAL DRIVE UNIT INFORMATION:

MAY REQUIRE ADDITIONAL SPRINGS FOR TUNING SUCH AS:

1/8"(P/N 73716), 1/4"(P/N 73745), AND 3/8"(P/N 73750)

CONTACT MOORFEED FOR PRICING AND AVAILABILITY.

PHONE: (317) 545-7171 FAX: (317) 542-7317 EMAIL: SPARES@MOORFEED.COM

MOORFEED DRIVE UNIT SPARE PARTS LIST

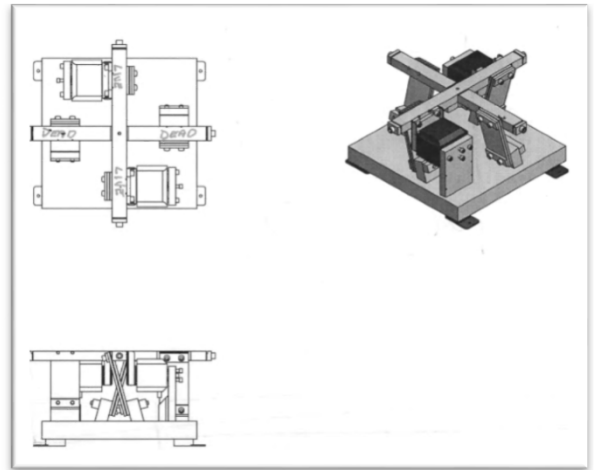

DRIVE UNIT MODEL #

73698

DRIVE UNIT SIZE: 36"

DRIVE UNIT VOLTAGE: 120

DRIVE FREQUENCY: HALF WAVE

NUMBER OF POSTS: 8

DRIVE ROTATION: CCW

COIL PART NUMBER: 83821

SPRING INFORMATION:

SIZE: 3/16"
PART #: 73730

SPACER INFORMATION:

PART #: 73722

TOE CLAMP PART NUMBER: 73618

MOUNTING FOOT PART NUMBER: 89261

CROSS ARM PART NUMBER: 73665

**RECOMMENDED
QUANTITY**

2 EACH

8 EACH

16 EACH

AS NEEDED

AS NEEDED

ADDITIONAL DRIVE UNIT INFORMATION:

MAY REQUIRE ADDITIONAL SPRINGS FOR TUNING SUCH AS:

1/4"(P/N 73716), 3/16"(P/N 73730), AND 3/8"(P/N 73750)

CONTACT MOORFEED FOR PRICING AND AVAILABILITY.

PHONE: (317) 545-7171 FAX: (317) 542-7317 EMAIL: SPARES@MOORFEED.COM

MOORFEED INLINE DRIVE UNIT SPARE PARTS LIST

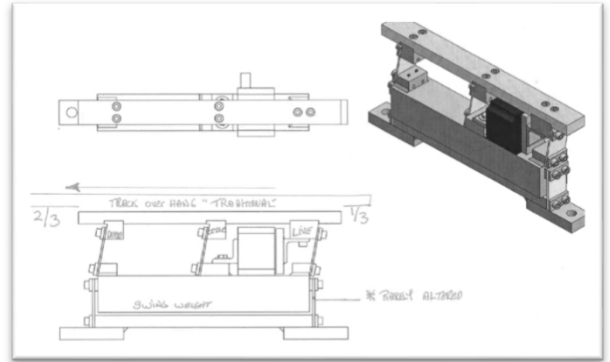

INLINE MODEL #

78141

INLINE UNIT SIZE: S-2

UNIT VOLTAGE: 120 VAC

COIL PART NUMBER: 83820

SPRING INFORMATION:

SIZE: 3/32"

PART #: 78106

SIZE: 1/8"

PART #: 78107

SPACER INFORMATION:

PART #: 78108

MOUNTING FOOT PART NUMBER: N/A

RECOMMENDED QUANTITIES

 1 EACH

 1 EACH

 1 EACH

 4 EACH

ADDITIONAL INLINE DRIVE UNIT INFORMATION:

TUNING KIT: PART # 78098

INCLUDES: 2-3/32" SPRING(P/N 78106), 2-1/8" SPRING(P/N 78107), 6-SPRING SPACER(P/N 78108)

CONTACT MOORFEED FOR PRICING AND AVAILABILITY.
 PHONE: (317) 545-7171 FAX: (317) 542-7317 EMAIL: SPARES@MOORFEED.COM

MOORFEED INLINE DRIVE UNIT SPARE PARTS LIST

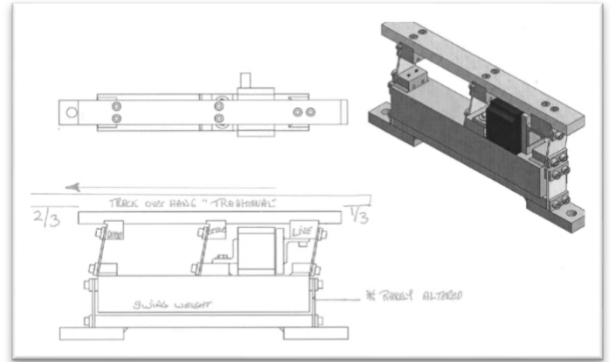

INLINE MODEL #

78142

INLINE UNIT SIZE: S-3

UNIT VOLTAGE: 120

COIL PART NUMBER: 83820

SPRING INFORMATION:

SIZE: 3/32"

PART #: 78106

SIZE: 1/8"

PART #: 78107

SPACER INFORMATION:

PART #: 78108

MOUNTING FOOT PART NUMBER: N/A

**RECOMMENDED
QUANTITIES**

 1 EACH

 1 EACH

 1 EACH

 4 EACH

ADDITIONAL INLINE DRIVE UNIT INFORMATION:

TUNING KIT: PART # 78098

INCLUDES: 2-3/32" SPRING(P/N 78106), 2-1/8" SPRING(P/N 78107), 6-SPRING SPACER(P/N 78108)

CONTACT MOORFEED FOR PRICING AND AVAILABILITY.
PHONE: (317) 545-7171 FAX: (317) 542-7317 EMAIL: SPARES@MOORFEED.COM

MOORFEED INLINE DRIVE UNIT SPARE PARTS LIST

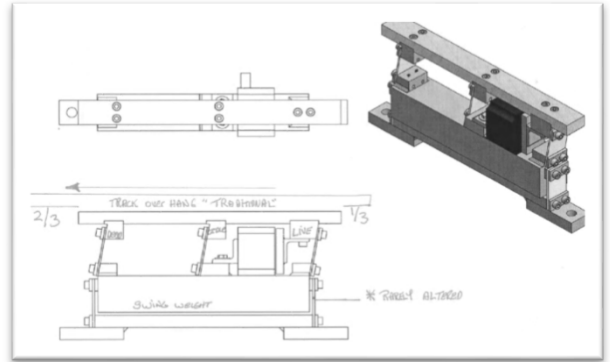

INLINE MODEL #

78143

INLINE UNIT SIZE: S-4

UNIT VOLTAGE: 120

COIL PART NUMBER: 83820

SPRING INFORMATION:

SIZE: 3/32"

PART #: 78106

SIZE: 1/8"

PART #: 78107

SPACER INFORMATION:

PART #: 78108

MOUNTING FOOT PART NUMBER: N/A

**RECOMMENDED
QUANTITIES**

 1 EACH

 1 EACH

 1 EACH

 4 EACH

ADDITIONAL INLINE DRIVE UNIT INFORMATION:

TUNING KIT: PART # 78098

INCLUDES: 2-3/32" SPRING(P/N 78106), 2-1/8" SPRING(P/N 78107), 6-SPRING SPACER(P/N 78108)

CONTACT MOORFEED FOR PRICING AND AVAILABILITY.
PHONE: (317) 545-7171 FAX: (317) 542-7317 EMAIL: SPARES@MOORFEED.COM

MOORFEED INLINE DRIVE UNIT SPARE PARTS LIST

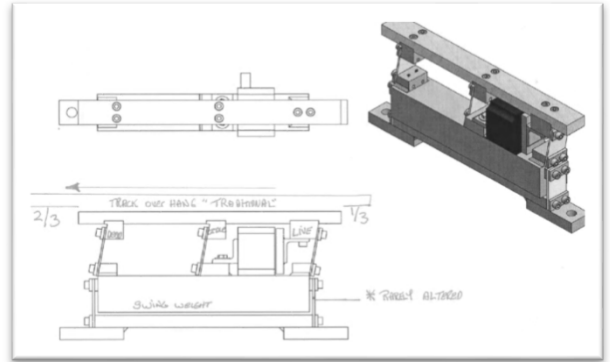

INLINE MODEL #

78144

INLINE UNIT SIZE: S-5

UNIT VOLTAGE: 120

COIL PART NUMBER: 83820

SPRING INFORMATION:

SIZE: 3/32"

PART #: 78106

SIZE: 1/8"

PART #: 78107

SPACER INFORMATION:

PART #: 78108

MOUNTING FOOT PART NUMBER: N/A

**RECOMMENDED
QUANTITIES**

 1 EACH

 1 EACH

 1 EACH

 4 EACH

ADDITIONAL INLINE DRIVE UNIT INFORMATION:

TUNING KIT: PART # 78098

INCLUDES: 2-3/32" SPRING(P/N 78106), 2-1/8" SPRING(P/N 78107), 6-SPRING SPACER(P/N 78108)

CONTACT MOORFEED FOR PRICING AND AVAILABILITY.
PHONE: (317) 545-7171 FAX: (317) 542-7317 EMAIL: SPARES@MOORFEED.COM

MOORFEED INLINE DRIVE UNIT SPARE PARTS LIST

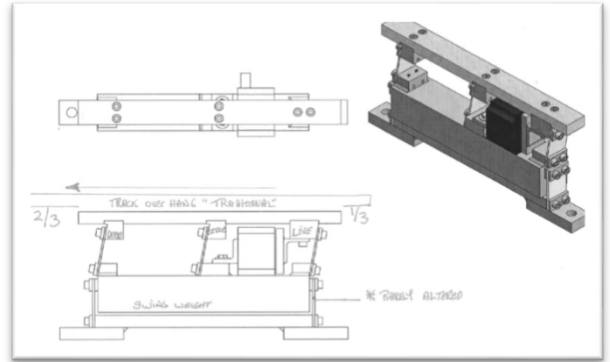

INLINE MODEL #

78145

INLINE UNIT SIZE: S-6

UNIT VOLTAGE: 120

COIL PART NUMBER: 83820

SPRING INFORMATION:

SIZE: 3/32"

PART #: 78106

SIZE: 1/8"

PART #: 78107

SPACER INFORMATION:

PART #: 78108

MOUNTING FOOT PART NUMBER: N/A

RECOMMENDED QUANTITIES

 1 EACH

 1 EACH

 1 EACH

 1 EACH

ADDITIONAL INLINE DRIVE UNIT INFORMATION:

TUNING KIT: PART # 78098

INCLUDES: 2-3/32" SPRING(P/N 78106), 2-1/8" SPRING(P/N 78107), 6-SPRING SPACER(P/N 78108)

CONTACT MOORFEED FOR PRICING AND AVAILABILITY.
 PHONE: (317) 545-7171 FAX: (317) 542-7317 EMAIL: SPARES@MOORFEED.COM

MOORFEED INLINE DRIVE UNIT SPARE PARTS LIST

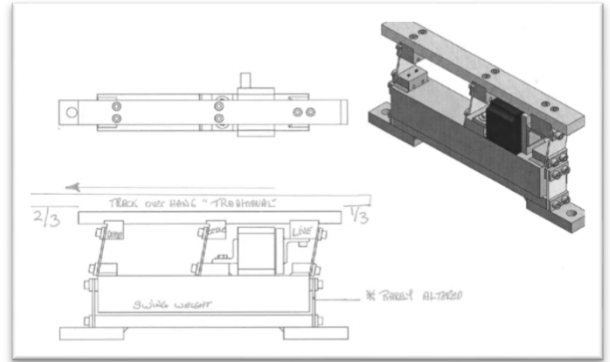

INLINE MODEL #

78181

INLINE UNIT SIZE: S-2

UNIT VOLTAGE: 220

COIL PART NUMBER: 83720

SPRING INFORMATION:

SIZE: 3/32"

PART #: 78106

SIZE: 1/8"

PART #: 78107

SPACER INFORMATION:

PART #: 78108

MOUNTING FOOT PART NUMBER: N/A

**RECOMMENDED
QUANTITIES**

 1 EACH

 1 EACH

 1 EACH

 4 EACH

ADDITIONAL INLINE DRIVE UNIT INFORMATION:

TUNING KIT: PART # 78098

INCLUDES: 2-3/32" SPRING(P/N 78106), 2-1/8" SPRING(P/N78107), 6-SPRING SPACER(P/N 78108)

CONTACT MOORFEED FOR PRICING AND AVAILABILITY.

PHONE: (317) 545-7171 FAX: (317) 542-7317 EMAIL: SPARES@MOORFEED.COM

MOORFEED INLINE DRIVE UNIT SPARE PARTS LIST

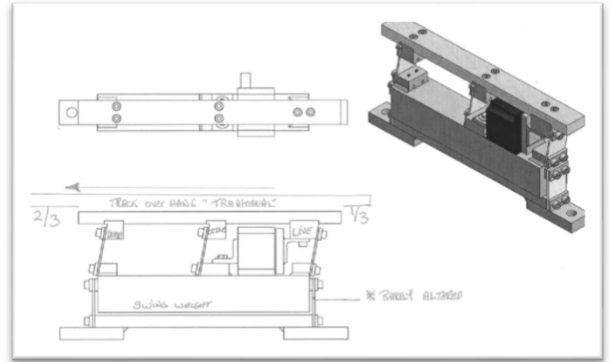

INLINE MODEL #

78182

INLINE UNIT SIZE: S-3

UNIT VOLTAGE: 220

COIL PART NUMBER: 83720

SPRING INFORMATION:

SIZE: 3/32"

PART #: 78106

SIZE: 1/8"

PART #: 78107

SPACER INFORMATION:

PART #: 78108

MOUNTING FOOT PART NUMBER: N/A

**RECOMMENDED
QUANTITIES**

 1 EACH

 1 EACH

 1 EACH

 4 EACH

ADDITIONAL INLINE DRIVE UNIT INFORMATION:

TUNING KIT: PART # 78098

INCLUDES: 2-3/32" SPRING(P/N 78106), 2-1/8" SPRING(P/N78107), 6-SPRING SPACER(P/N 78108)

CONTACT MOORFEED FOR PRICING AND AVAILABILITY.

PHONE: (317) 545-7171 FAX: (317) 542-7317 EMAIL: SPARES@MOORFEED.COM

MOORFEED INLINE DRIVE UNIT SPARE PARTS LIST

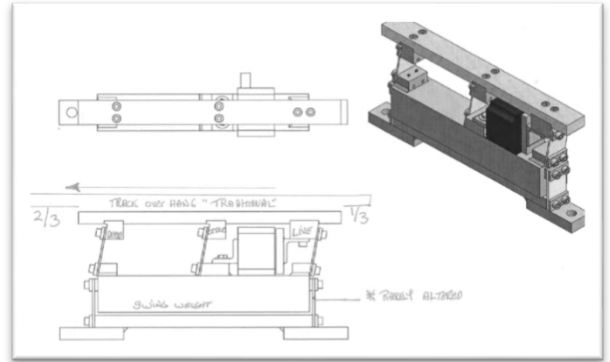

INLINE MODEL #

78183

INLINE UNIT SIZE: S-4

UNIT VOLTAGE: 220

COIL PART NUMBER: 83720

SPRING INFORMATION:

SIZE: 3/32"

PART #: 78106

SIZE: 1/8"

PART #: 78107

SPACER INFORMATION:

PART #: 78108

MOUNTING FOOT PART NUMBER: N/A

RECOMMENDED QUANTITIES

 1 EACH

 1 EACH

 1 EACH

 4 EACH

ADDITIONAL INLINE DRIVE UNIT INFORMATION:

TUNING KIT: PART # 78098

INCLUDES: 2-3/32" SPRING(P/N 78106), 2-1/8" SPRING(P/N 78107), 6-SPRING SPACER(P/N 78108)

CONTACT MOORFEED FOR PRICING AND AVAILABILITY.
 PHONE: (317) 545-7171 FAX: (317) 542-7317 EMAIL: SPARES@MOORFEED.COM

MOORFEED INLINE DRIVE UNIT SPARE PARTS LIST

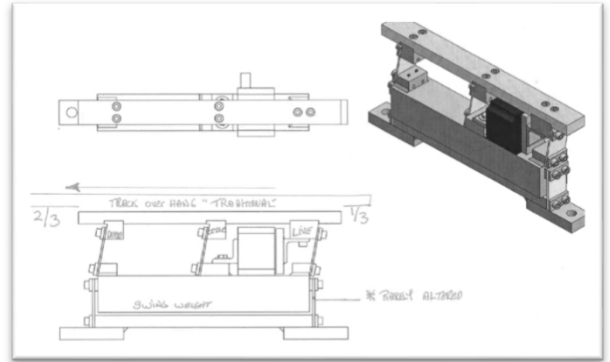

INLINE MODEL #

78184

INLINE UNIT SIZE: S-5

UNIT VOLTAGE: 220

COIL PART NUMBER: 83720

SPRING INFORMATION:

SIZE: 3/32"

PART #: 78106

SIZE: 1/8"

PART #: 78107

SPACER INFORMATION:

PART #: 78108

MOUNTING FOOT PART NUMBER: N/A

RECOMMENDED QUANTITIES

 1 EACH

 1 EACH

 1 EACH

 4 EACH

ADDITIONAL INLINE DRIVE UNIT INFORMATION:

TUNING KIT: PART # 78098

INCLUDES: 2-3/32" SPRING(P/N 78106), 2-1/8" SPRING(P/N 78107), 6-SPRING SPACER(P/N 78108)

CONTACT MOORFEED FOR PRICING AND AVAILABILITY.
 PHONE: (317) 545-7171 FAX: (317) 542-7317 EMAIL: SPARES@MOORFEED.COM

MOORFEED INLINE DRIVE UNIT SPARE PARTS LIST

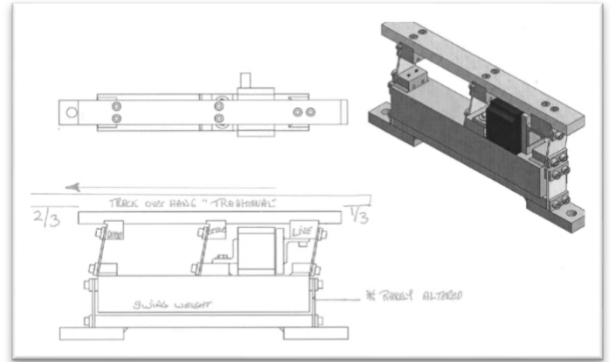

INLINE MODEL #

78185

INLINE UNIT SIZE: S-6

UNIT VOLTAGE: 220

COIL PART NUMBER: 83720

SPRING INFORMATION:

SIZE: 3/32"

PART #: 78106

SIZE: 1/8"

PART #: 78107

SPACER INFORMATION:

PART #: 78108

MOUNTING FOOT PART NUMBER: N/A

**RECOMMENDED
QUANTITIES**

 1 EACH

 1 EACH

 1 EACH

 4 EACH

ADDITIONAL INLINE DRIVE UNIT INFORMATION:

TUNING KIT: PART # 78098

INCLUDES: 2-3/32" SPRING(P/N 78106), 2-1/8" SPRING(P/N 78107), 6-SPRING SPACERS(P/N 78108)

CONTACT MOORFEED FOR PRICING AND AVAILABILITY.

PHONE: (317) 545-7171 FAX: (317) 542-7317 EMAIL: SPARES@MOORFEED.COM

MOORFEED INLINE DRIVE UNIT SPARE PARTS LIST

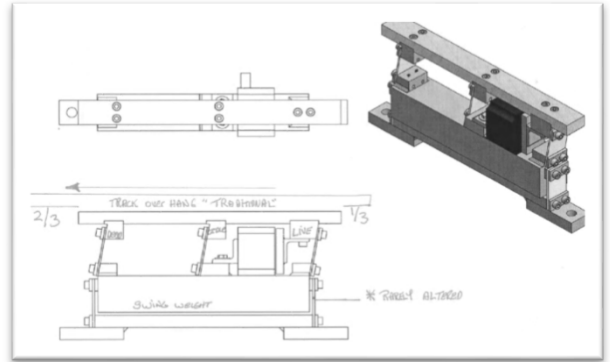

INLINE MODEL #

78171

INLINE UNIT SIZE: M-2

UNIT VOLTAGE: 120 VAC

COIL PART NUMBER: 83823

SPRING INFORMATION:

SIZE: 3/32"

PART #: 78116

SIZE: 1/16"

PART #: 78117

SPACER INFORMATION:

PART #: 78118

MOUNTING FOOT PART NUMBER: N/A

**RECOMMENDED
QUANTITIES**

 1 EACH

 2 EACH

 2 EACH

 8 EACH

ADDITIONAL INLINE DRIVE UNIT INFORMATION:

M-SERIES TUNING KIT: PART # 78097

INCLUDES: 2-3/32" SPRING M-SERIES (P/N 78116), 2-1/16" SPRING M-SERIES (P/N 78117),

6-SPRING SPACER(P/N 78118)

CONTACT MOORFEED FOR PRICING AND AVAILABILITY.

PHONE: (317) 545-7171 FAX: (317) 542-7317 EMAIL: SPARES@MOORFEED.COM

MOORFEED INLINE DRIVE UNIT SPARE PARTS LIST

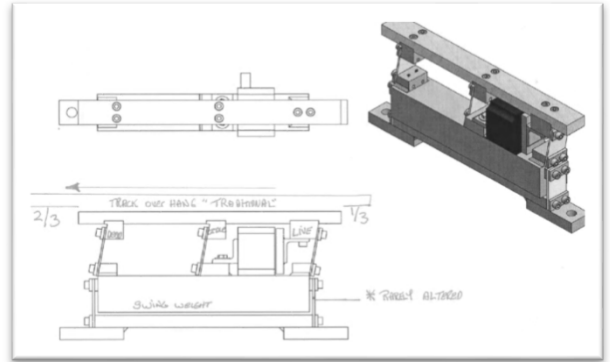

INLINE MODEL #

78172

INLINE UNIT SIZE: M-3 SM INLINE

UNIT VOLTAGE: 120

COIL PART NUMBER: 83823

SPRING INFORMATION:

SIZE: 3/32" M-SERIES

PART #: 78116

SIZE: 1/16" M-SERIES

PART #: 78117

SPACER INFORMATION:

PART #: 78118

MOUNTING FOOT PART NUMBER: N/A

RECOMMENDED QUANTITIES

 1 EACH

 2 EACH

 3 EACH

 10 EACH

ADDITIONAL INLINE DRIVE UNIT INFORMATION:

M-SERIES TUNING KIT: PART # 78097

 INCLUDES: 2-3/32" SPRING M-SERIES(P/N 78116), 2- 1/16" SPRING M-SERIES(P/N 78117)

 6-SPRING SPACER(P/N 78118)

CONTACT MOORFEED FOR PRICING AND AVAILABILITY.
 PHONE: (317) 545-7171 FAX: (317) 542-7317 EMAIL: SPARES@MOORFEED.COM

MOORFEED INLINE DRIVE UNIT SPARE PARTS LIST

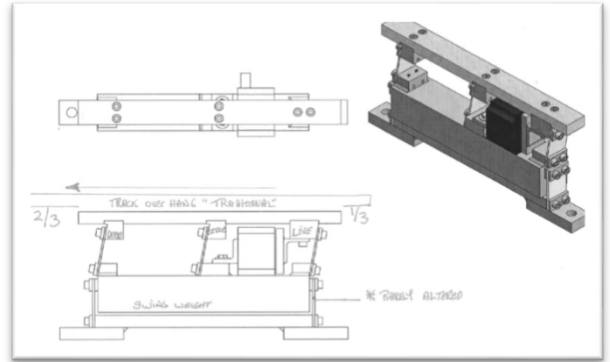

INLINE MODEL #

78173

INLINE UNIT SIZE: M-4 SM INLINE

UNIT VOLTAGE: 120

COIL PART NUMBER: 83823

SPRING INFORMATION:

SIZE: 3/32"

PART #: 78116

SIZE: 1/16"

PART #: 78117

SPACER INFORMATION:

PART #: 78118

MOUNTING FOOT PART NUMBER: N/A

**RECOMMENDED
QUANTITIES**

1 EACH

2 EACH

4 EACH

12 EACH

ADDITIONAL INLINE DRIVE UNIT INFORMATION:

M-SERIES TUNING KIT: PART # 78097

INCLUDES: 2-3/32" SPRING M-SERIES(P/N 78116), 2-1/16" SPRING M-SERIES(P/N 78117),

6-SPRING SPACER(P/N 78118)

CONTACT MOORFEED FOR PRICING AND AVAILABILITY.

PHONE: (317) 545-7171 FAX: (317) 542-7317 EMAIL: SPARES@MOORFEED.COM

MOORFEED INLINE DRIVE UNIT SPARE PARTS LIST

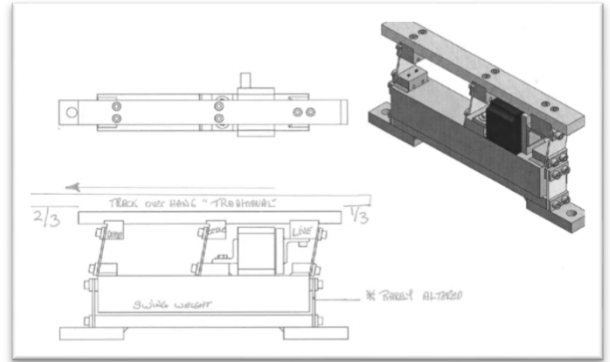

INLINE MODEL #

78174

INLINE UNIT SIZE: M-5 SM INLINE

UNIT VOLTAGE: 120

COIL PART NUMBER: 83823

SPRING INFORMATION:

SIZE: 3/32" M-SERIES

PART #: 78116

SIZE: 1/19" M-SERIES

PART #: 78117

SPACER INFORMATION:

PART #: 78118

MOUNTING FOOT PART NUMBER: N/A

RECOMMENDED QUANTITIES

 1 EACH

 2 EACH

 5 EACH

 14 EACH

ADDITIONAL INLINE DRIVE UNIT INFORMATION:

M-SERIES TUNING KIT: PART # 78097

 INCLUDES: 2-3/32" SPRING M-SERIES(P/N 78116), 2-1/16" SPRING M SERIES(P/N 78117)

 6-SPRING SPACER(P/N 78118)

CONTACT MOORFEED FOR PRICING AND AVAILABILITY.
 PHONE: (317) 545-7171 FAX: (317) 542-7317 EMAIL: SPARES@MOORFEED.COM

MOORFEED INLINE DRIVE UNIT SPARE PARTS LIST

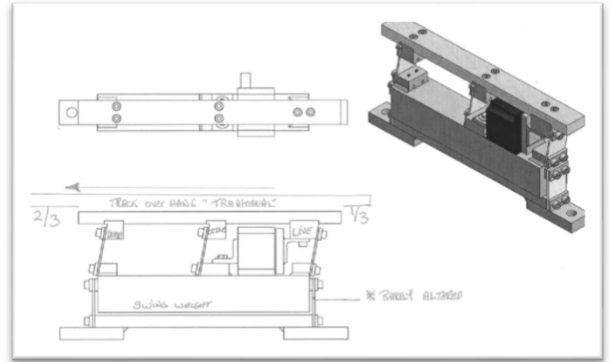

INLINE MODEL #

78175

INLINE UNIT SIZE: M-6 SM INLINE

UNIT VOLTAGE: 120

COIL PART NUMBER: 83823

SPRING INFORMATION:

SIZE: 3/32" M-SERIES

PART #: 78116

SIZE: 1/16" M-SERIES

PART #: 78117

SPACER INFORMATION:

PART #: 78118

MOUNTING FOOT PART NUMBER: N/A

RECOMMENDED QUANTITIES

 1 EACH

 2 EACH

 6 EACH

 16 EACH

ADDITIONAL INLINE DRIVE UNIT INFORMATION:

M-SERIES TUNING KIT: PART # 78097

INCLUDES: 2-3/32" SPRING M-SERIES(P/N 78116), 2-1/16 SPRING M-SERIES(P/N 78117)

6-SPRING SPACER(78118)

CONTACT MOORFEED FOR PRICING AND AVAILABILITY.
 PHONE: (317) 545-7171 FAX: (317) 542-7317 EMAIL: SPARES@MOORFEED.COM

MOORFEED INLINE DRIVE UNIT SPARE PARTS LIST

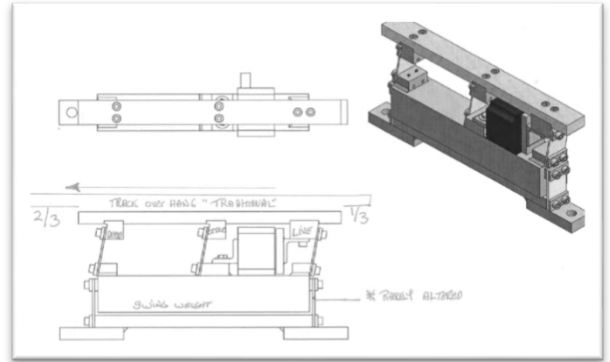

INLINE MODEL #

78191

INLINE UNIT SIZE: M-2

UNIT VOLTAGE: 220

COIL PART NUMBER: 83723

SPRING INFORMATION:

SIZE: 3/32"

PART #: 78116

SIZE: 1/16"

PART #: 78117

SPACER INFORMATION:

PART #: 78118

MOUNTING FOOT PART NUMBER: N/A

**RECOMMENDED
QUANTITIES**

 1 EACH

 2 EACH

 2 EACH

 4 EACH

ADDITIONAL INLINE DRIVE UNIT INFORMATION:

M-SERIES TUNING KIT: PART # 78097

INCLUDES: 2-3/32" SPRING M-SERIES(P/N 78116), 2-1/16" SPRING M-SERIES(P/N 78117),

6-SPRING SPACER(P/N 78118)

CONTACT MOORFEED FOR PRICING AND AVAILABILITY.

PHONE: (317) 545-7171 FAX: (317) 542-7317 EMAIL: SPARES@MOORFEED.COM

MOORFEED INLINE DRIVE UNIT SPARE PARTS LIST

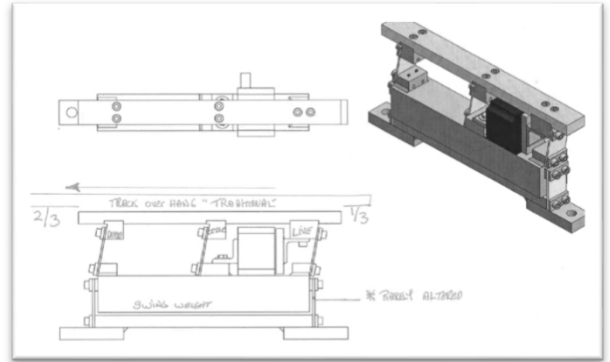

INLINE MODEL #

78192

INLINE UNIT SIZE: M-3

UNIT VOLTAGE: 220

COIL PART NUMBER: 83723

SPRING INFORMATION:

SIZE: 3/32"
 PART #: 78116
 SIZE: 1/16"
 PART #: 78117

SPACER INFORMATION:

PART #: 78118

MOUNTING FOOT PART NUMBER: N/A

RECOMMENDED QUANTITIES

 1 EACH

 2 EACH

 3 EACH

 10 EACH

ADDITIONAL DRIVE UNIT INFORMATION:

M-SERIES TUNING KIT: PART # 78097

 INCLUDES: 2-3/32" SPRING M-SERIES(P/N 78816), 2-1/16" SPRING M-SERIES (P/N 78117),
 6-SPRING SPACER(78118)

CONTACT MOORFEED FOR PRICING AND AVAILABILITY.
 PHONE: (317) 545-7171 FAX: (317) 542-7317 EMAIL: SPARES@MOORFEED.COM

MOORFEED INLINE DRIVE UNIT SPARE PARTS LIST

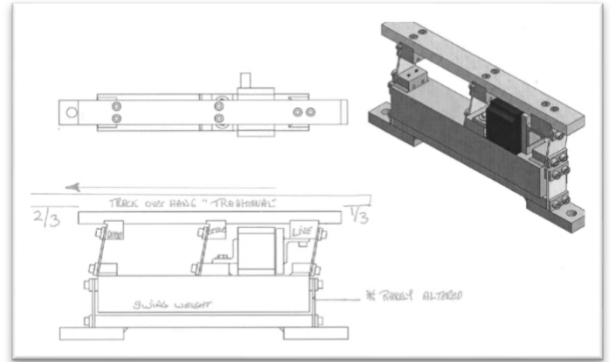

INLINE MODEL #

78193

INLINE UNIT SIZE: M-4

UNIT VOLTAGE: 220

COIL PART NUMBER: 83723

SPRING INFORMATION:

SIZE: 3/32"

PART #: 78116

SIZE: 1/16"

PART #: 78117

SPACER INFORMATION:

PART #: 78118

MOUNTING FOOT PART NUMBER: N/A

RECOMMENDED QUANTITIES

 1 EACH

 2 EACH

 4 EACH

 12 EACH

ADDITIONAL INLINE DRIVE UNIT INFORMATION:

M-SERIES TUNING KIT: PART # 78097

INCLUDES: 2-3/32" SPRING M-SERIES(P/N 78116), 2-1/16" SPRING M-SERIES(P/N 78117)

6-SPRING SPACER(P/N 78118)

CONTACT MOORFEED FOR PRICING AND AVAILABILITY.
 PHONE: (317) 545-7171 FAX: (317) 542-7317 EMAIL: SPARES@MOORFEED.COM

MOORFEED INLINE DRIVE UNIT SPARE PARTS LIST

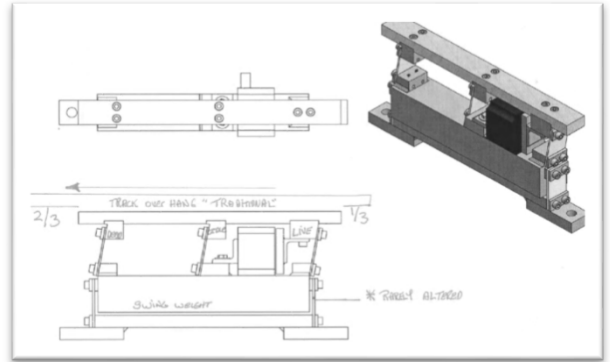

INLINE MODEL #

78194

INLINE UNIT SIZE: M-5

UNIT VOLTAGE: 220

COIL PART NUMBER: 83723

SPRING INFORMATION:

SIZE: 3/32"

PART #: 78116

SIZE: 1/16"

PART #: 78117

SPACER INFORMATION:

PART #: 78118

MOUNTING FOOT PART NUMBER: N/A

RECOMMENDED QUANTITIES

 1 EACH

 2 EACH

 5 EACH

 14 EACH

ADDITIONAL DRIVE UNIT INFORMATION:

M-SERIES TUNING KIT: PART # 78097

 INCLUDES: 2-3/32" SPRING M-SERIES(P/N 78116), 2-1/16" SPRING M-SERIES(P/N 78117)

 6-SPRING SPACER(P/N 78118)

CONTACT MOORFEED FOR PRICING AND AVAILABILITY.
 PHONE: (317) 545-7171 FAX: (317) 542-7317 EMAIL: SPARES@MOORFEED.COM

MOORFEED INLINE DRIVE UNIT SPARE PARTS LIST

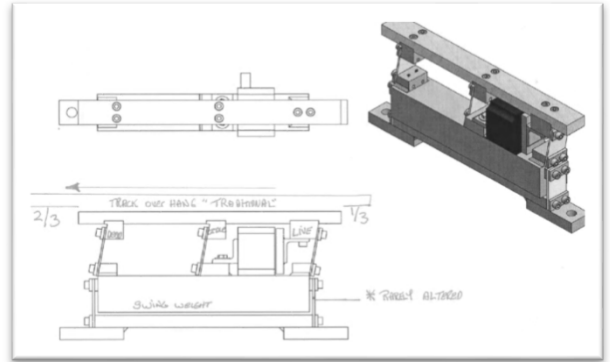

INLINE MODEL #

78195

INLINE UNIT SIZE: M-6

UNIT VOLTAGE: 220

COIL PART NUMBER: 83723

SPRING INFORMATION:

SIZE: 3/32"

PART #: 78116

SIZE: 1/16"

PART #: 78117

SPACER INFORMATION:

PART #: 78118

MOUNTING FOOT PART NUMBER: N/A

RECOMMENDED QUANTITIES

 1 EACH

 2 EACH

 6 EACH

 16 EACH

ADDITIONAL DRIVE UNIT INFORMATION:

M-SERIES TUNING KIT: PART # 78097

 INCLUDES: 2-3/32" SPRING M-SERIES(P/N 78116), 2-1/16" SPRING M-SERIES (P/N 78117)

 6-SPRING SPACER(P/N 78118)

CONTACT MOORFEED FOR PRICING AND AVAILABILITY.
PHONE: (317) 545-7171 FAX: (317) 542-7317 EMAIL: SPARES@MOORFEED.COM

MOORFEED INLINE DRIVE UNIT SPARE PARTS LIST

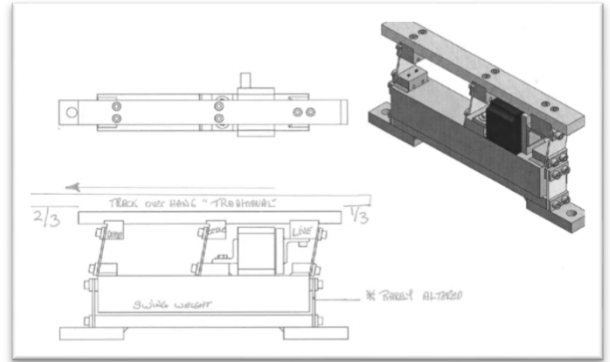

INLINE MODEL #

78803

INLINE UNIT SIZE: 8.5 INLINE

UNIT VOLTAGE: 220 VOLT

COIL PART NUMBER: 83718

SPRING INFORMATION:

SIZE: 1/16"
PART #: 78815

SPACER INFORMATION:

PART #: 78819

MOUNTING FOOT PART NUMBER: N/A

**RECOMMENDED
QUANTITIES**

1 EACH

2 EACH

4 EACH

ADDITIONAL INLINE DRIVE UNIT INFORMATION:

TUNING MAY REQUIRE USE OF 1/32" SPRING(P/N 78816)

CONTACT MOORFEED FOR PRICING AND AVAILABILITY.

PHONE: (317) 545-7171 FAX: (317) 542-7317 EMAIL: SPARES@MOORFEED.COM

MOORFEED INLINE DRIVE UNIT SPARE PARTS LIST

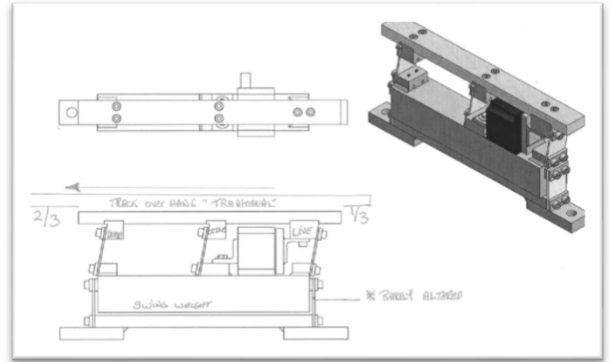

INLINE MODEL #

780004

INLINE UNIT SIZE: 16" RUBBER MOUNT

UNIT VOLTAGE: 120

COIL PART NUMBER: 83823

SPRING INFORMATION:

SIZE: 1/16" THICK
PART #: 78015

SPACER INFORMATION:

PART #: 78019

MOUNTING FOOT PART NUMBER: N/A

**RECOMMENDED
QUANTITIES**

1 EACH

4 EACH

8 EACH

ADDITIONAL INLINE DRIVE UNIT INFORMATION:

TUNING MAY REQUIRE USE OF 1/32 SPRING(P/N 78016)

CONTACT MOORFEED FOR PRICING AND AVAILABILITY.
PHONE: (317) 545-7171 FAX: (317) 542-7317 EMAIL: SPARES@MOORFEED.COM

MOORFEED INLINE DRIVE UNIT SPARE PARTS LIST

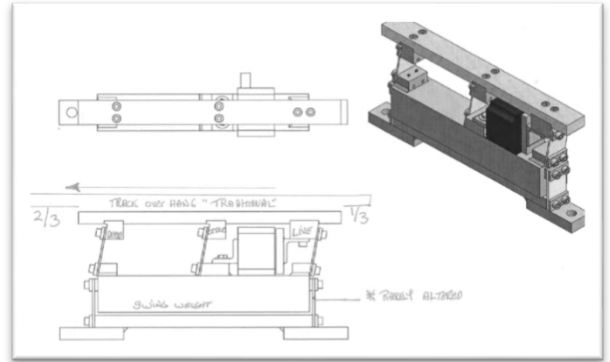

INLINE MODEL #

780005

INLINE UNIT SIZE: 16" RUBBER MOUNT

UNIT VOLTAGE: 220

COIL PART NUMBER: 83723

SPRING INFORMATION:

SIZE: 1/16" THICK
PART #: 78015

SPACER INFORMATION:

PART #: 78019

MOUNTING FOOT PART NUMBER: N/A

**RECOMMENDED
QUANTITIES**

1 EACH

4 EACH

8 EACH

ADDITIONAL DRIVE UNIT INFORMATION:

TUNING MAY REQUIRE USE OF 1/32" SPRING(P/N 78016)

CONTACT MOORFEED FOR PRICING AND AVAILABILITY.

PHONE: (317) 545-7171 FAX: (317) 542-7317 EMAIL: SPARES@MOORFEED.COM